

RESTRICTED

WAR DEPARTMENT TECHNICAL MANUAL

TM 9-392

This TM supersedes WDTB 9X-98, dated 10 Jan 45, and Changes No. 1, dated Apr 45.

4.5-INCH MULTIPLE
ROCKET LAUNCHERS
T66 AND T66E2



WAR DEPARTMENT

JULY 1945

*United States Government Printing Office
Washington : 1952*

RESTRICTED

WAR DEPARTMENT

Washington 25, D. C., 14 July 1945

TM 9-392, 4.5-inch Multiple Rocket Launchers T66 and T66E2,
is published for the information and guidance of all concerned.

[A.G. 300.7 (11 Jul 45)
O.O. 300.7/4544]

BY ORDER OF THE SECRETARY OF WAR:

G. C. MARSHALL,
Chief of Staff.

OFFICIAL:

EDWARD F. WITSELL,
Major General,
Acting The Adjutant General.

DISTRIBUTION: AGF (2); ASF (2); S Div ASF (1); T of Opn (10);
Arm & Sv Bd (1) except Rocket Bd (5); Gen & Sp Sv
Sch (1) except FA Sch (25); USMA (2); A (Ord O)
(1); CHQ (Ord O) (1); D (Ord O) (1); T/O & E
6-86 (5).

(For explanation of symbols, see FM 21-6.)

CONTENTS

PART ONE—INTRODUCTION

SECTION		Paragraphs	Pages
	I. General	1- 2	1- 2
	II. Description and data	3- 6	2-10
	III. Tools, parts and accessories	7- 8	10-11

PART TWO—OPERATING INSTRUCTIONS

SECTION	IV. General	9	12
	V. Service upon receipt of equipment	10-12	12-13
	VI. Controls and instruments	13-19	13-16
	VII. Operation under usual conditions	20-24	16-27
	VIII. Operation of auxiliary equipment	25	27
	IX. Operation under unusual conditions	26-30	28-30
	X. Demolition to prevent enemy use	31-33	30-31

PART THREE—MAINTENANCE INSTRUCTIONS

SECTION	XI. General	34-35	32
	XII. Lubrication	36-37	32-37
	XIII. Preventive maintenance service	38-39	38
	XIV. Malfunctions and corrections	40	39-40
	XV. Tube cluster	41-42	40-42
	XVI. Firing mechanism	43-44	42-43
	XVII. Carriage	45-46	43-44
	XVIII. Trails and tie rods	47-48	44
	XIX. Control box	49	44-46
	XX. Elevating mechanism	50-51	46
	XXI. Traversing mechanism	52-53	47

PART THREE—MAINTENANCE INSTRUCTIONS—Contd.

	Paragraphs	Pages
SECTION XXII. Firing pedestal	54	47
XXIII. Sight bracket	55	47
XXIV. Wheels	56-57	47-48

PART FOUR—AUXILIARY EQUIPMENT

SECTION XXV. General	58	49
XXVI. Ammunition	59-64	49-57
XXVII. Sighting and fire control equipment	65-69	57-68

APPENDIX

SECTION XXVIII. Shipment and storage	70-72	69-78
XXIX. References	73-76	79-80
INDEX		81-82

RESTRICTED

This TM supersedes WDTB 9X-98, dated 10 Jan 45, and Changes No. 1, dated 25 Apr. 45.

PART ONE—INTRODUCTION**Section I****GENERAL****1. SCOPE.***

a. This manual is published for the information of the using arms and services.

b. In addition to a description of the 4.5-inch multiple rocket launchers T66 and T66E2, this manual contains technical information required for the identification, use, and care of the weapon, ammunition, and accessory equipment.

c. In all cases where the nature of the repair, modification, or adjustment is beyond the scope or facilities of the unit, the responsible ordnance service should be informed so that trained personnel with suitable tools and equipment may be provided, or proper instructions issued.

2. RECORDS.**a. Artillery Gun Book.**

(1) The Artillery Gun Book (O.O. Form 5825) is used for the purpose of keeping an accurate record of the materiel. It must always remain with the materiel regardless of where it may be sent. The book is divided as follows: record of assignment; battery commander's daily gun record; and inspector's record of examination. This book should be in the possession of the organization at all times, and its completeness of records and its whereabouts are the responsibility of the battery commander. It must also contain date of issuance of the materiel, by whom used, and the place where issued. If a new tube cluster is installed on the carriage, all data recorded in the old book with reference to sights, mounts, etc., must be copied into the new book before the old book is relinquished. If a gun book is lost, it should be replaced at once and all entries brought up to date. Additional copies may be obtained by requisition to Office, Chief of Ordnance, Ordnance Service Division, Supply Branch, Attn: SPOGA-5, Washington 25, D. C., on WD AGO Form No. 445. **NOTE:** *Record of assignment data must be removed and destroyed prior to entering combat.*

*To provide operating instructions with the materiel, this Technical Manual has been published in advance of complete technical review. Any errors or omissions will be corrected by changes or, if extensive, by an early revision.

Part One—Introduction

(2) Complete instructions on how to make entries in the Artillery Gun Book are contained therein. It is absolutely essential that the gun book entries be kept complete and up to date. In order to facilitate proper maintenance of the rocket launcher and its related materiel (that is, carriage and associated fire control equipment) and to avoid unnecessary duplication of repairs and maintenance, the following additional entries are to be made in the gun book.

(a) *A record of completed modification work orders.* This record should show the date completed and bear the signature of the officer or mechanic responsible for completion of the modification.

(3) The estimated accuracy life of the tube cluster is 300 salvos.

b. *Field report of accidents.* When an accident involving ammunition occurs during practice, the incident will be reported as prescribed in AR 750-10 by the ordnance officer under whose supervision the ammunition is maintained or issued. Where practicable, reports covering malfunctions of ammunition in combat will be made to the Chief of Ordnance, giving the type of malfunction, the type of ammunition, the lot number of the complete rounds or separate-loading components, and condition under which fired.

c. *Unsatisfactory equipment report.* Suggestions for improvement in design, maintenance, safety, and efficiency of operation prompted by chronic failure or malfunction of the weapon, spare parts, or equipment should be reported on WD AGO Form No. 468, Unsatisfactory Equipment Report, with all pertinent information necessary to initiate corrective action. The report should be forwarded to the Office, Chief of Ordnance, Field Service, Maintenance Division, through command channels in accordance with instruction No. 7 on the form. If WD AGO Form No. 468 is not available, refer to TM 37-250 for list of data required on unsatisfactory equipment report. Such suggestions are encouraged in order that other organizations may benefit.

Section II**DESCRIPTION AND DATA****3. GENERAL.**

a. The 4.5-inch multiple rocket launchers T66 and T66E2 (figs. 1, 2, 3, and 4) are light, mobile, towed vehicles capable of coarse adjustments in elevation or traverse, and used to launch 4.5-inch spin-type rockets.

b. The 4.5-inch multiple rocket launchers T66 and T66E2 are used against area targets, utilizing direct and indirect sighting. For

Part One—Introduction

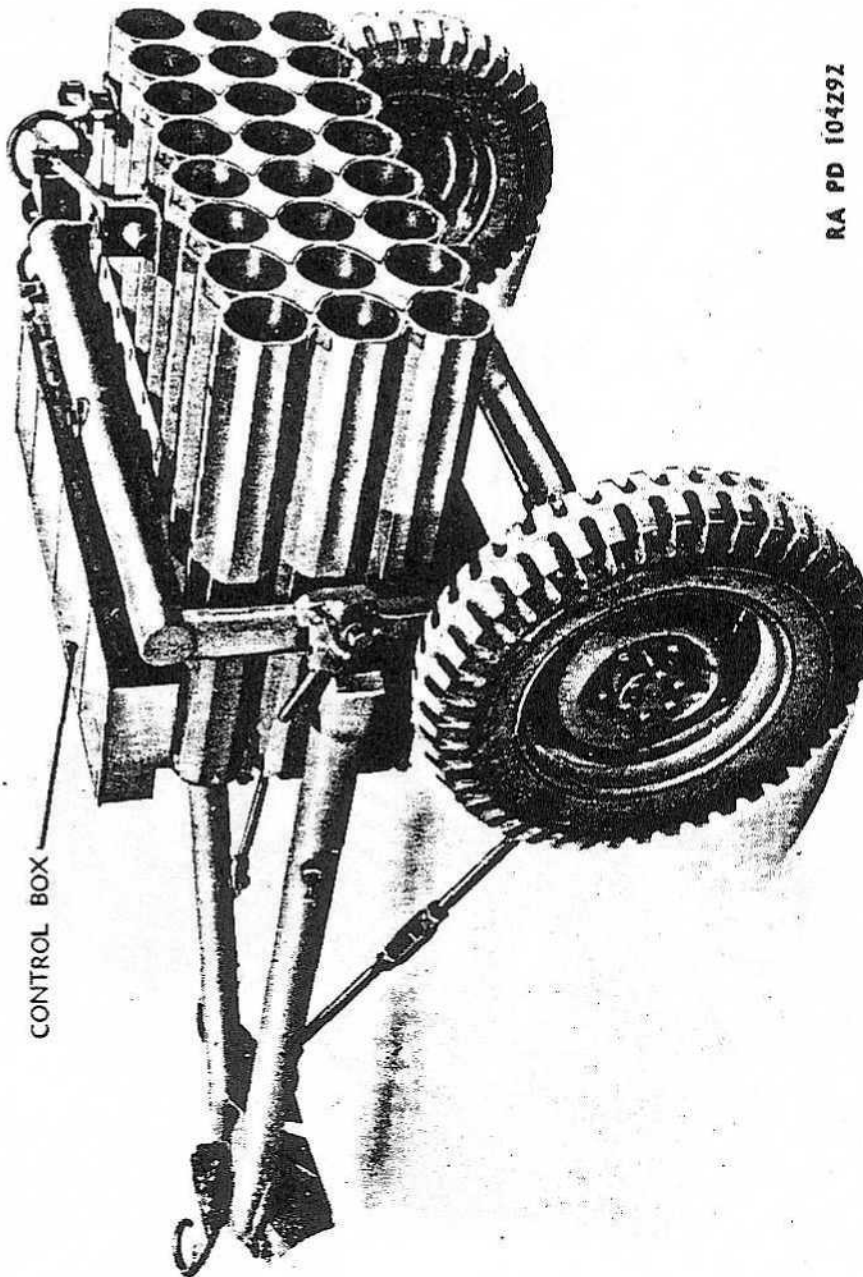

RA PD 104292

Figure 1—Launcher T66 in Traveling Position—Front View

Part One—Introduction

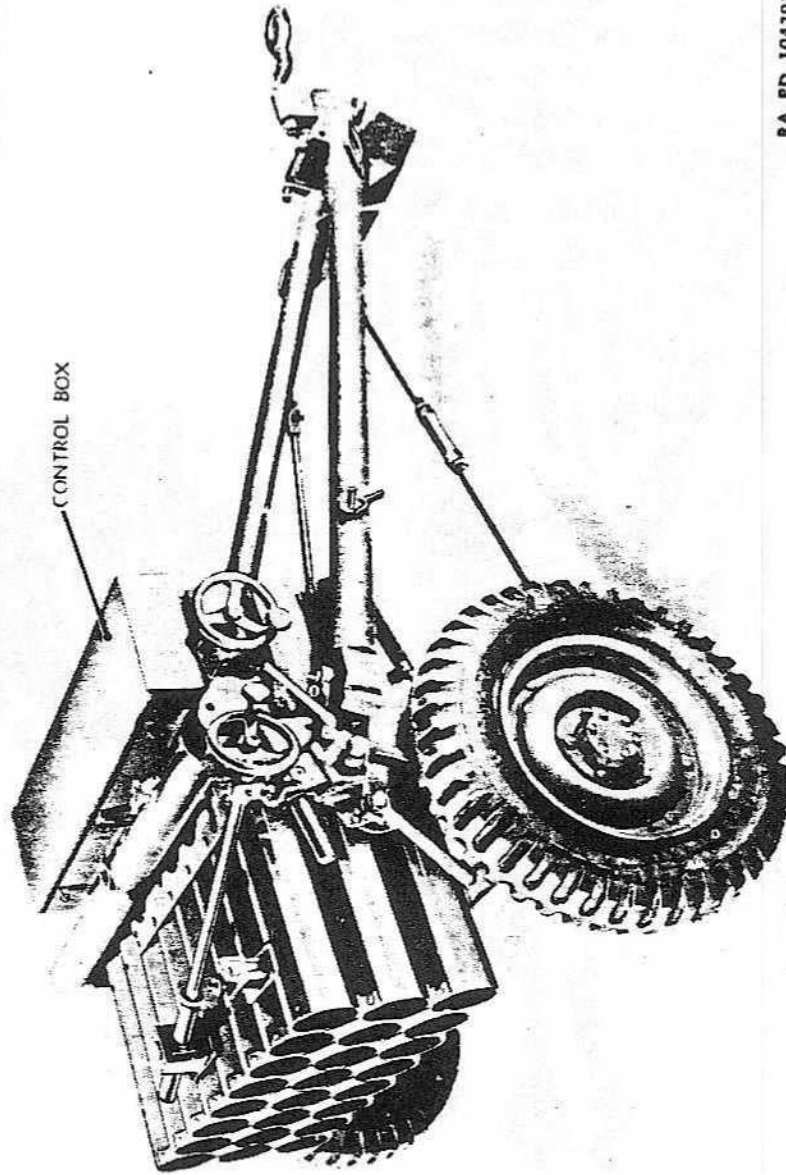

RA PD 104293

Figure 2—Launcher T66E2 in Traveling Position—Front View

Part One—Introduction

RA PD 96035

Figure 51—Sling Methods Used in Hoisting Artillery Materiel

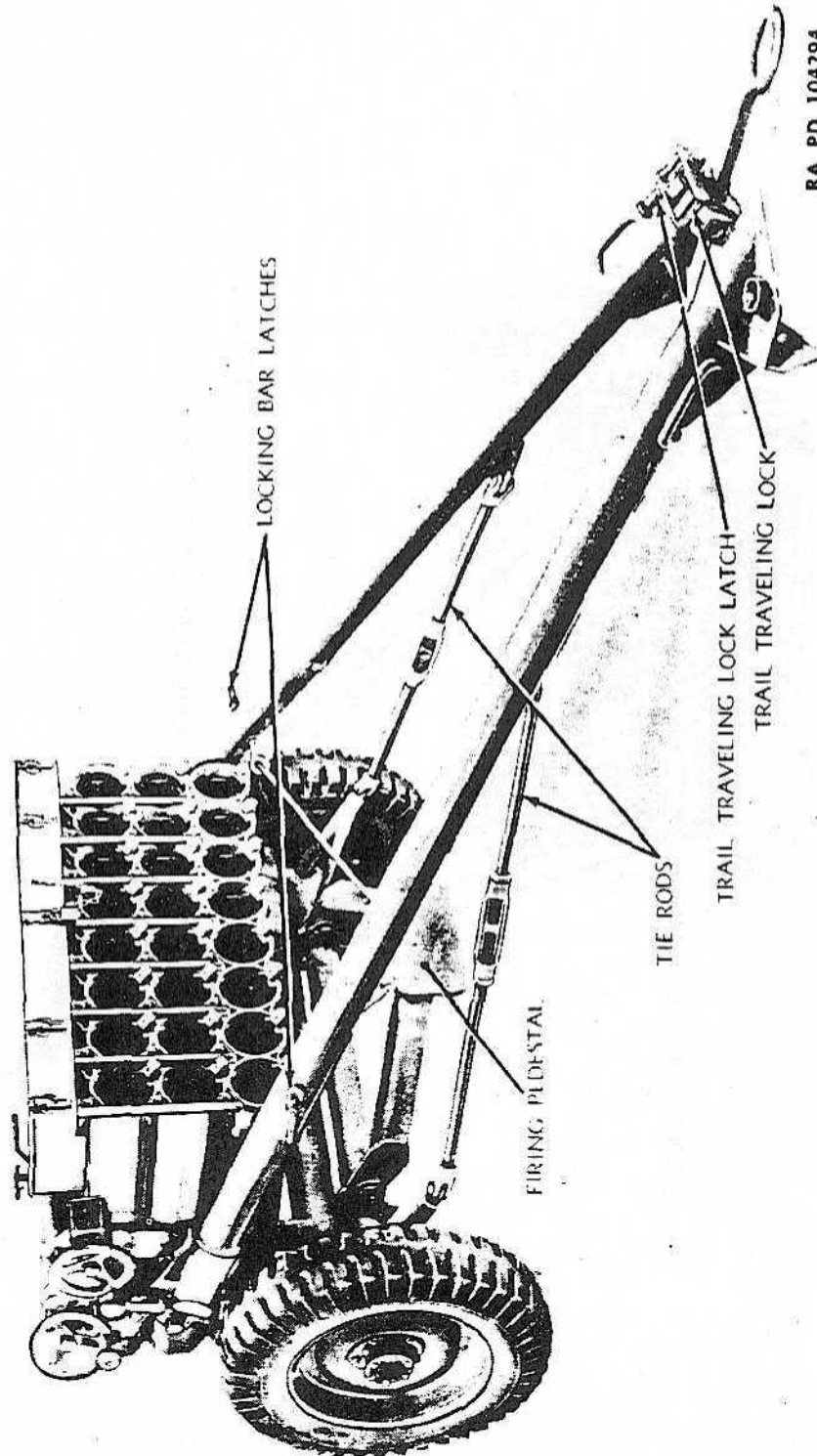

RA PD 104294

Figure 3—Launcher T66. In Traveling Position—Rear View

Part One—Introduction

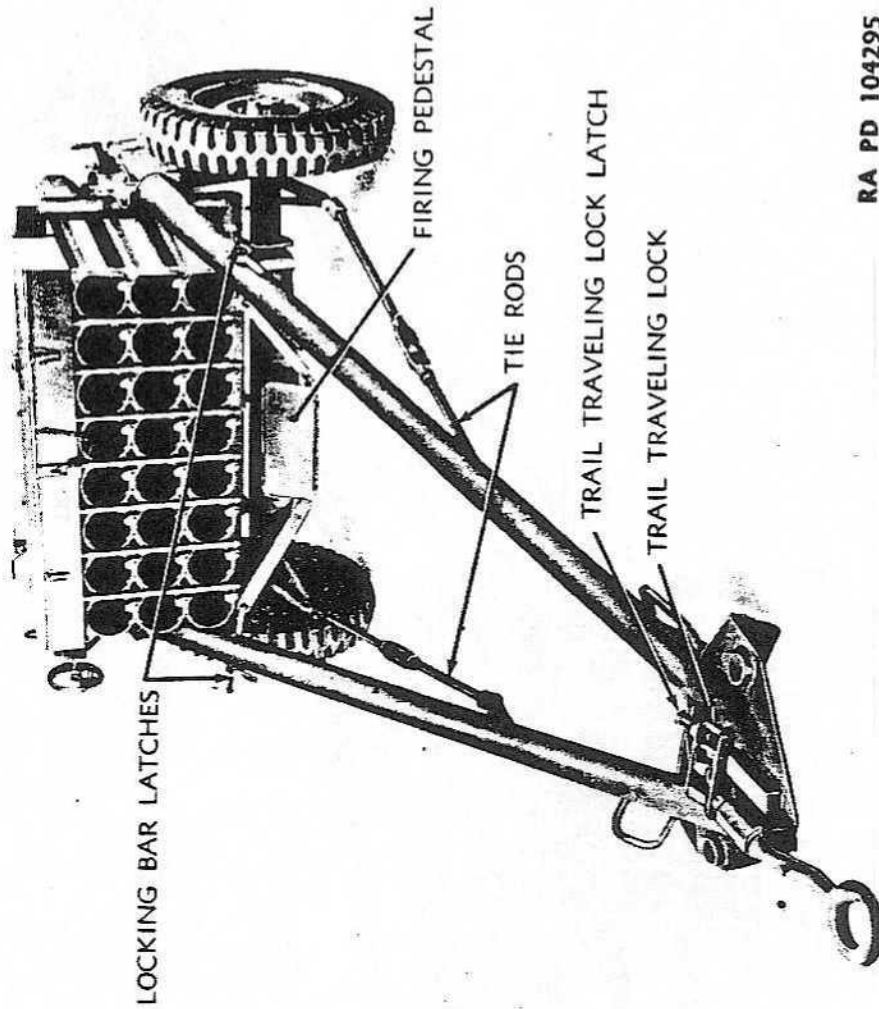

RA PD 104295

Figure 4—Launcher T66E2 in Traveling Position—Rear View

Part One—Introduction

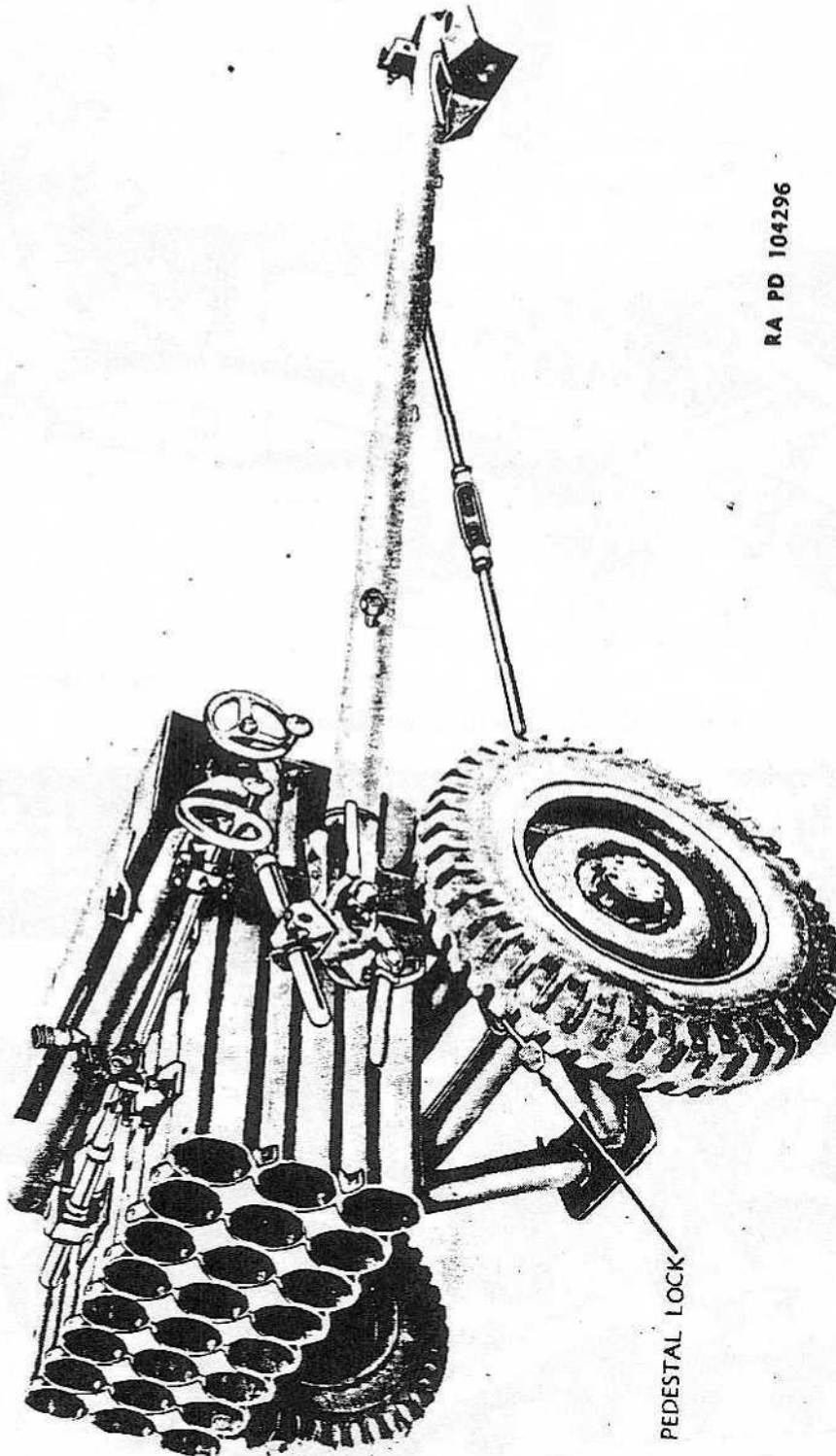

RA PD 104296

Figure 5—Launcher T66 in Firing Position—Front View

Part One—Introduction

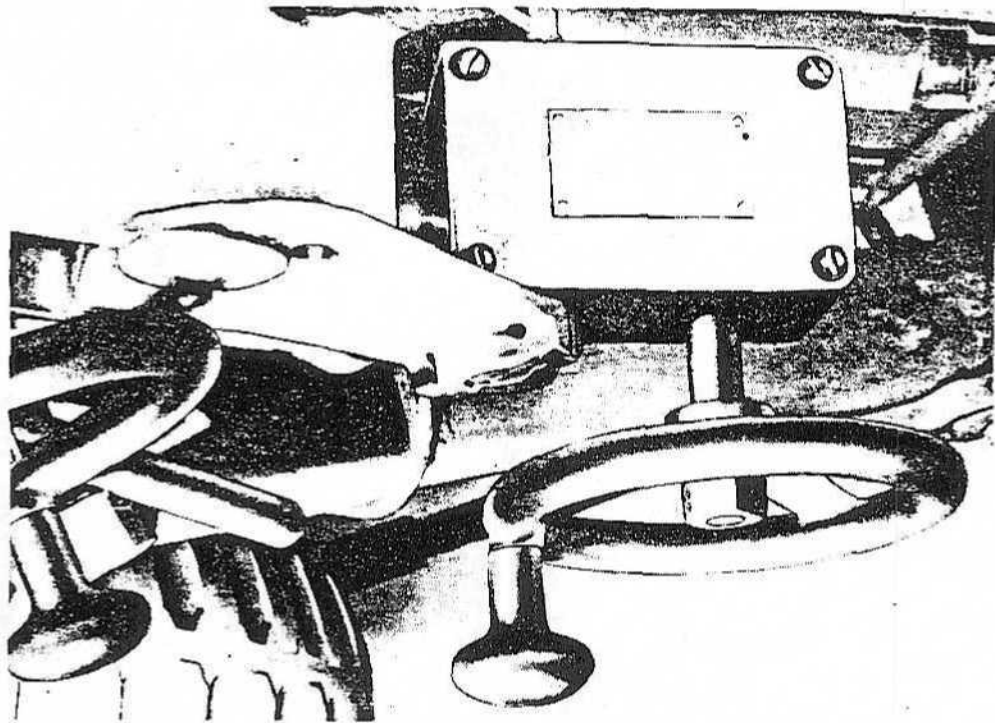

RA PD 104297

Figure 6—Nameplate on Launcher T66

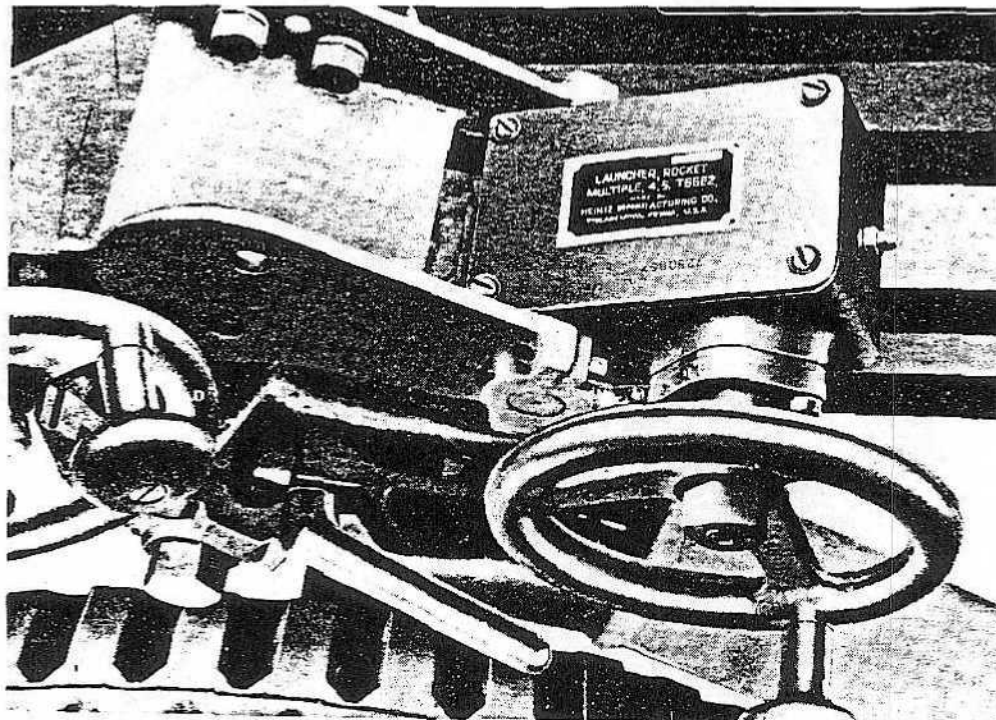

RA PD 104298

Figure 7—Nameplate on Launcher T66E2

Part One—Introduction

firing, the trails are spread and the firing pedestal is lowered to the ground in firing position for 3-point suspension (fig. 5). For traveling, the trails are locked together and the firing pedestal is raised in traveling position and locked (figs. 3 and 4). The weapon is towed by a prime mover. The ammunition used with this weapon is loaded into the muzzle of the tubes by hand.

4. IDENTIFICATION INFORMATION.

a. One serial number is required for records concerning the components of this materiel, the launcher serial number.

b. Launcher serial number. This number appears on a plate on the top face of the elevating mechanism housing (figs. 6 and 7).

5. DIFFERENCES IN MODELS. The 4.5-inch multiple rocket launchers T66 are the first 206 weapons built of this type. The multiple rocket launchers T66E2 are the next 300 weapons built, employing modifications on the T66. The T66E2 launcher incorporates an improved elevating mechanism, a blackout lighting system, new lunette, redesigned utility box to house the blackout lighting system, redesigned conductor cable (50 feet in length) to use the Amphanol fitting to the blasting machine, redesigned contact fingers and holding assembly, and also a different sight.

6. TABULATED DATA.

a. Data pertaining to 4.5-inch multiple rocket launchers T66 and T66E2.

	MODEL	
	T66	T66E2
Number of tubes	24	24
Elevation of tubes	0 to 45 deg	0 to 45 deg
Traverse of tubes (total)	20 deg	20 deg
Length of tube	36 in.	36 in.
Firing mechanism	ten-cap exploder	ten-cap exploder
Tires:		
Number	2	2
Size	6.00 x 16	6.00 x 16
Pressure	35 lb	35 lb
Weight of launcher (approx) (w/lunette 21 inches from ground)	1,200 lb	1,270 lb
Combined weight under left and right tires (approx) (w/lunette 21 inches from ground)	1,100 lb	1,120 lb
Weight under spade (approx) (w/lunette 21 inches from ground)	100 lb	152 lb
Weight of Ten-cap exploder (approx)	5 lb	5 lb
Ammunition	For complete ammunition data, see section XXVI	

Part One—Introduction

b. Sighting equipment.

SIGHTUNIT, T128E1 w/e

(Consisting of:

MOUNT, telescope, T148E1

TELESCOPE, elbow, M62

ADAPTER, telescope, M9

LIGHT, instrument, M42)

SIGHTUNIT, T127E1 w/e

(Consisting of:

QUADRANT, elevation, T13E5

TELESCOPE, elbow, M62

ADAPTER, telescope, M9

LIGHT, instrument, M42)

LIGHT, instrument, M42

MOUNT, telescope, T72E1

TELESCOPE, elbow, M62

ADAPTER, telescope, M9

LIGHT, instrument, T16

c. Fire control equipment.

LIGHT, aiming post, M14, green filter

LIGHT, aiming post, M14, red filter

SET, aiming post, M1

Section III

TOOLS, PARTS AND ACCESSORIES

7. ORGANIZATIONAL SPARE PARTS. A set of organizational spare parts is supplied to the using arms for field replacement of those parts most likely to become broken, worn, or otherwise unserviceable. The set will be kept complete by requisitioning new parts for those used. The parts comprising the set are listed below for information only; this list will not be used for requisitioning. The authority upon which requisitions are based is SNL C-67.

Spare Part	Piece Mark
BEAD, porcelain	7251799
BEARING, roller	7250912
INSULATOR, contact	A7250614
SCREW	7251812
SCREW, cap, hex. hd., S., 1/4-28NF-2 x 5/8	218394
SCREW, cap, hex. hd., S., 1/4-28NF-2 x 3/4	215912
SCREW, special, 1/8 long	A7250821
SCREW, special, hex. hd., 1/2-20NF-2 x 1 1/4	A7250902
SPRING, contact	A7250921
SPRING, ground	A7250817
WASHER, copper	7251806
WASHER, lock, internal teeth, heavy S.	111328
WASHER, lock, reg. S., 1/4 in.	103319
WASHER, plain, S., cd-pltd. U.S. std., 1/4 in.	120386

Part One—Introduction

8. ACCESSORIES.

a. Accessories include tools and equipment as are required by personnel for disassembling and assembling, and for the cleaning and preserving of the launcher. Accessories should not be used for purposes other than as prescribed, and when not in use should be properly stored.

b. The accessories provided with each launcher are listed below. If it becomes necessary to replace a broken or missing accessory, this list should be checked with SNL C-67 which is the authority for requisitioning.

Accessory	Piece Mark or Fed. Stock No.	Use
BLASTING MACHINE ASSEMBLY	C. 250630	It is used as a source of electricity for firing the rocket from the launcher.
BRUSH, assembly.....	B7250724	Clean launcher tubes.
BRUSH, and HANDLE ASSEMBLY	C7250645	Clean launcher tubes.
CABLE ASSEMBLY, 50 ft.....	B7250714	To connect blasting machine to firing box.
REEL, cable, assembly.....	C7250632	To accommodate cable assembly.
TOOL-KIT, assembly.....	C7250733	To repair and maintain launcher.
(Consisting of:		
1 KIT, tool.....	C7250657	
1 SCREWDRIVER, common, normal-duty, length of blade 6 in., width of blade $\frac{1}{8}$ in.....	41S- 1089	
1 WRENCH, box, $\frac{1}{8}$ x $\frac{1}{2}$	A7250904	
1 WRENCH, box, $\frac{1}{8}$ x $\frac{3}{8}$	B7250744	
1 WRENCH, box, $\frac{3}{4}$ x $\frac{7}{8}$	B7250743	
1 WRENCH, set or cap screw, plug-type, reg. short arm series, hex. $\frac{1}{8}$ in.....	41-W-2455	

PART TWO—OPERATING INSTRUCTIONS

Section IV

GENERAL

9. **SCOPE.** Part Two contains information for the guidance of the personnel responsible for the operation of this equipment. It contains information on the operation of the equipment, and the description and location of the controls and instruments.

Section V

SERVICE UPON RECEIPT OF EQUIPMENT

10. GENERAL.

a. Upon receipt of new or used materiel, it is the responsibility of the officer in charge to ascertain whether it is complete and in sound operating condition. A record should be made of any missing parts and of any malfunctions, and any such conditions should be corrected as quickly as possible.

b. Attention should be given to small and minor parts as these are the more likely to become lost and may seriously affect the proper functioning of the materiel.

c. The materiel should be cleaned and prepared for service in accordance with instructions given in paragraph 11 or 12. The materiel should be lubricated in accordance with section XII.

11. NEW EQUIPMENT.

a. Test firing circuits as follows:

CAUTION: *Make sure no rockets are in the launcher tubes.*

(1) Connect firing cable to firing box socket (fig. 20).

(2) Connect firing cable to blasting machine (figs. 24 and 25). Hold machine in left hand and insert firing handle.

(3) Operate the blasting machine. The indicator on the firing box dial should advance step by step each time the blasting machine handle is twisted.

b. Remove rust-preventive compound from tubes and from contact fingers and latches by scrubbing with dry-cleaning solvent, and then wipe thoroughly dry, using clean, dry burlap, or wiping cloths.

Part Two—Operating Instructions

c. Apply a light coat of preservative lubricating oil (special) to tubes and all base metal surfaces. Apply a few drops of preservative lubricating oil (special) to release assemblies.

12. USED EQUIPMENT.

a. Test firing circuits as outlined in paragraph 11 a and remove rust-preventive compound as outlined in paragraph 11 b.

b. Inspect contact fingers and latches to be sure they are not broken and are in operating condition.

Section VI

CONTROLS AND INSTRUMENTS

13. **TUBE CLUSTER TRAVELING LOCK.** The tube cluster traveling lock (fig. 8) aligns the tube cluster in zero traverse and prevents shifting of the cluster during traveling. To disengage the lock, the handle must be lifted and rotated.

14. **FIRING CONTROLS.** The weapon is fired by a blasting machine (fig. 9). This is done by twisting the firing handle.

15. TRAVERSING CONTROLS.

a. The traversing handwheel (fig. 8) traverses the weapon. This is done by rotating the handwheel after the traversing lock has been disengaged.

b. The traversing lock (fig. 8) retains the tube cluster in the desired position of traverse and locks the tube cluster for traveling. This is done by rotating the lock handle.

16. ELEVATING CONTROLS.

a. The elevating handwheel (fig. 8) elevates the weapon. This is done by rotating the handwheel after the elevating lock has been disengaged.

b. The elevating lock (fig. 8) retains the tube cluster in the desired angle of elevation or locks the tube cluster for traveling. This is done by rotating the lock handle.

Part Two—Operating Instructions

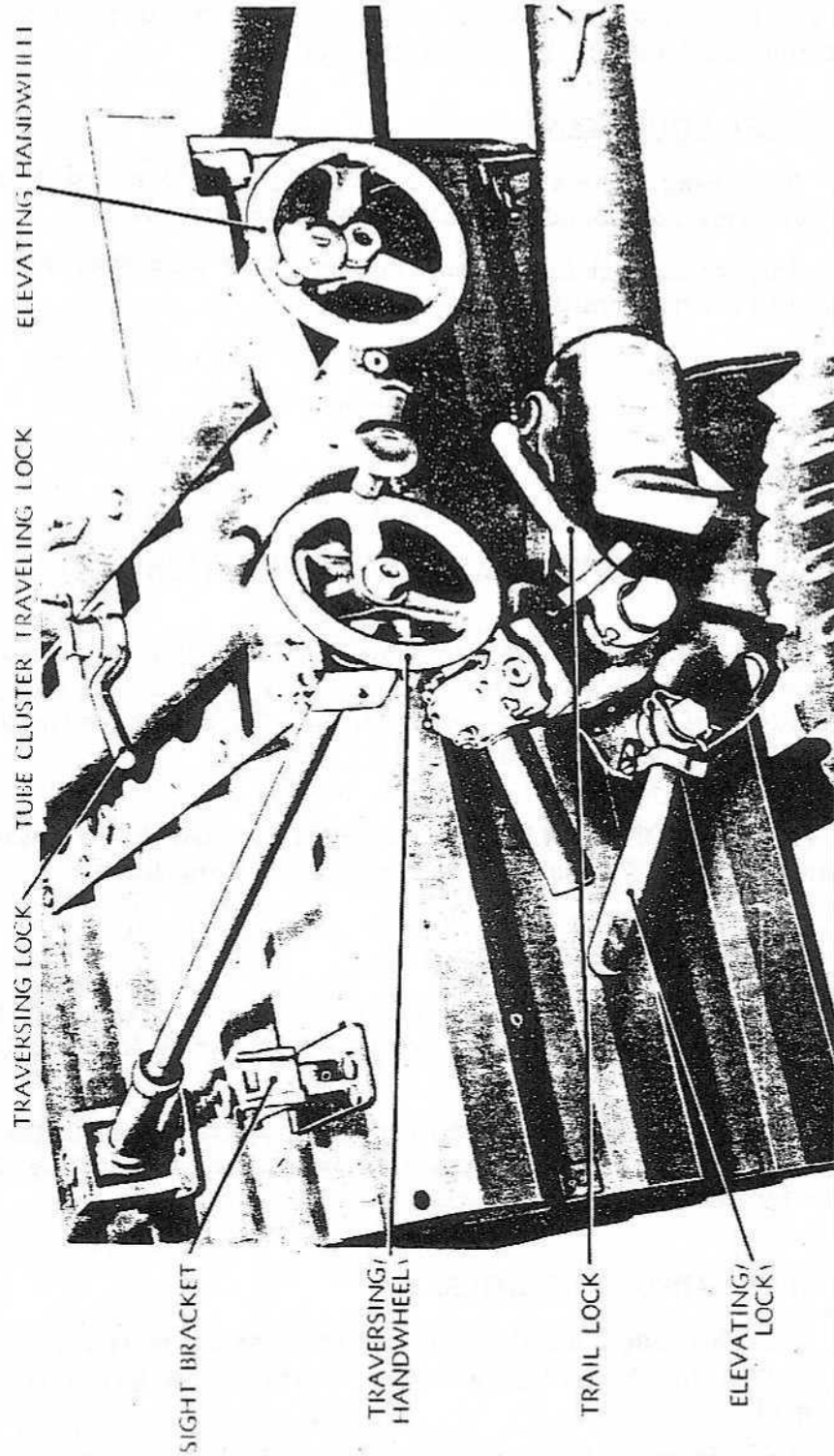

RA PD 104278

Figure 8—Details of Left Side of Launcher

Part Two—Operating Instructions

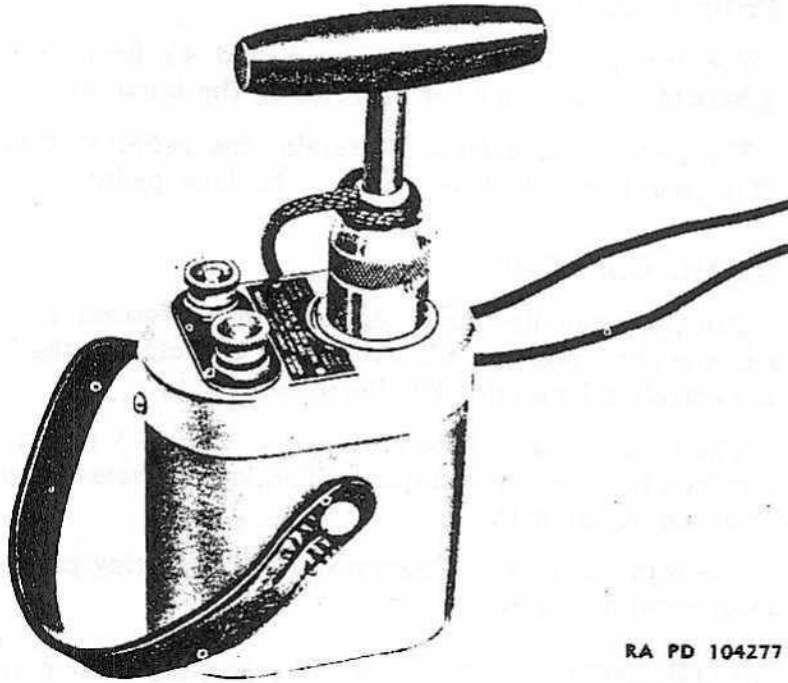

RA PD 104277

Figure 9—Blasting Machine

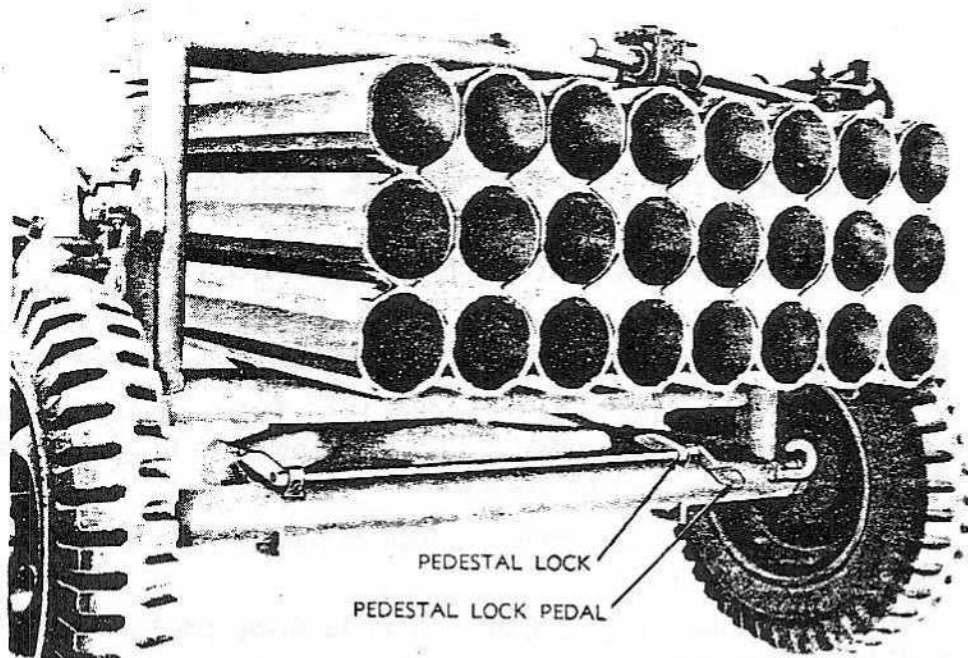

RA PD 104299

Figure 10—Pedestal Lock

Part Two—Operating Instructions

17. PEDESTAL CONTROLS.

a. The locking bar latches (figs. 3 and 4) keep the pedestal locking bars taut. This is done by rotating the latch levers.

b. The pedestal lock (fig. 10) retains the pedestal in firing position. The lock is released by pressing the lock pedal.

18. TRAIL CONTROLS.

a. The trail traveling lock (figs. 3 and 4) fastens the trails together in traveling position. This is done by rotating the lock lever after the traveling lock latch has been released.

b. The trail traveling lock latch (figs. 3 and 4) retains the trail traveling lock in the closed position. The latch is released by pulling the knob and rotating it.

c. The trail locks (fig. 8) retain the trails in firing position. This is done by rotating the lock handle.

19. INSTRUMENTS. The firing box consists of a dial with 24 numbered graduations and an indicator which shows the tube to be fired (figs. 22 and 23).

Section VII**OPERATION UNDER USUAL CONDITIONS****20. TO PLACE LAUNCHER IN FIRING POSITION.**

a. Remove launcher cover (fig. 11) and place it out of the way. Select terrain as level as possible on which to emplace the weapon.

b. Unscrew locking bar latches (fig. 12). Release firing pedestal locking bars from firing pedestal, and lower pedestal to ground (fig. 13). Place bars in their brackets on the trails.

c. Disengage the trail traveling lock to release the trails (figs. 14 and 15).

d. Spread the trails and lock them in firing position with the trail locks (fig. 16).

e. Tilt the launcher forward (fig. 17). The firing pedestal will fall into firing position. A click will be heard when the pedestal lock engages. Lower trails to ground.

Part Two—Operating Instructions

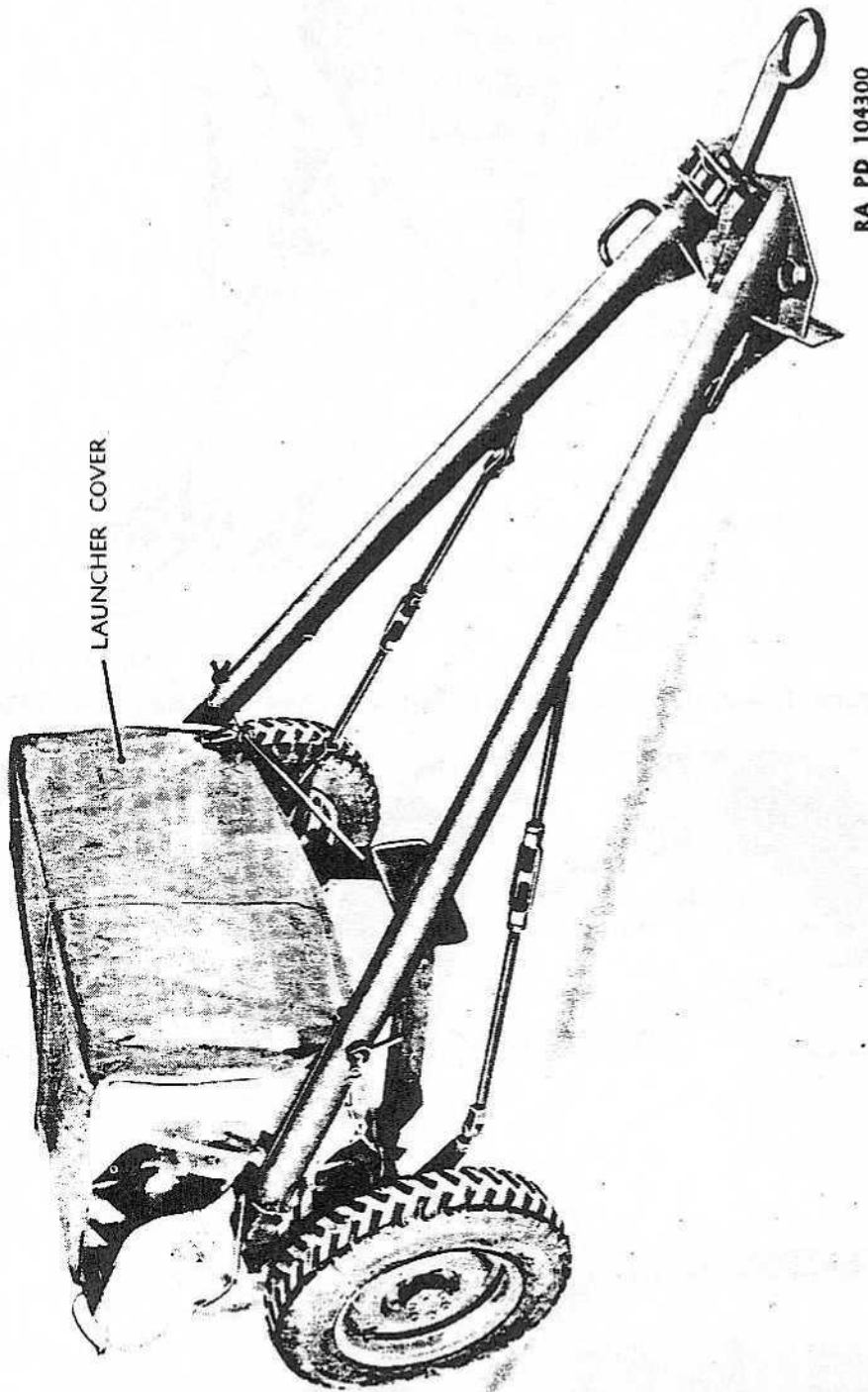
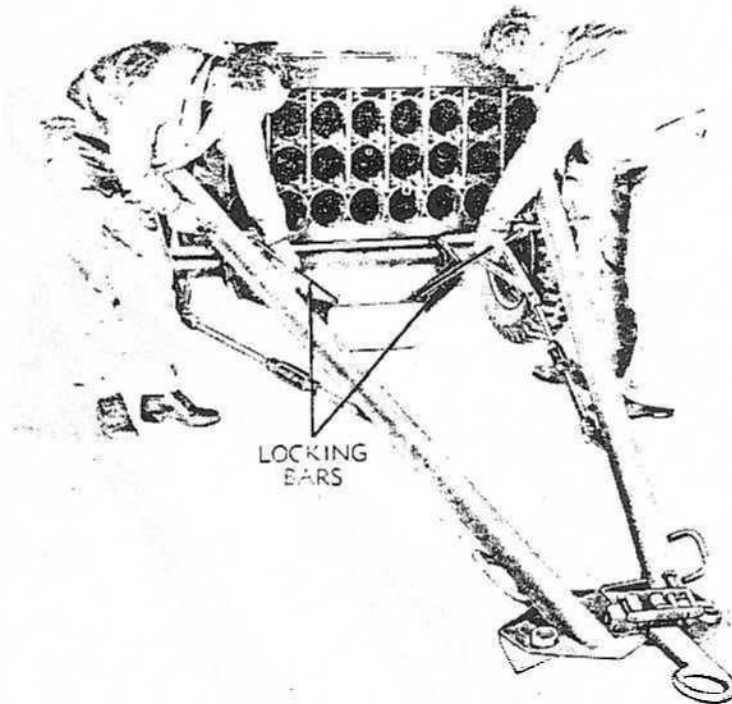

Figure 11—Launcher T66 in Traveling Position With Cover—Rear View

Part Two—Operating Instructions



RA PD 104301

Figure 12—Releasing Locking Bar Latches on Launcher T66

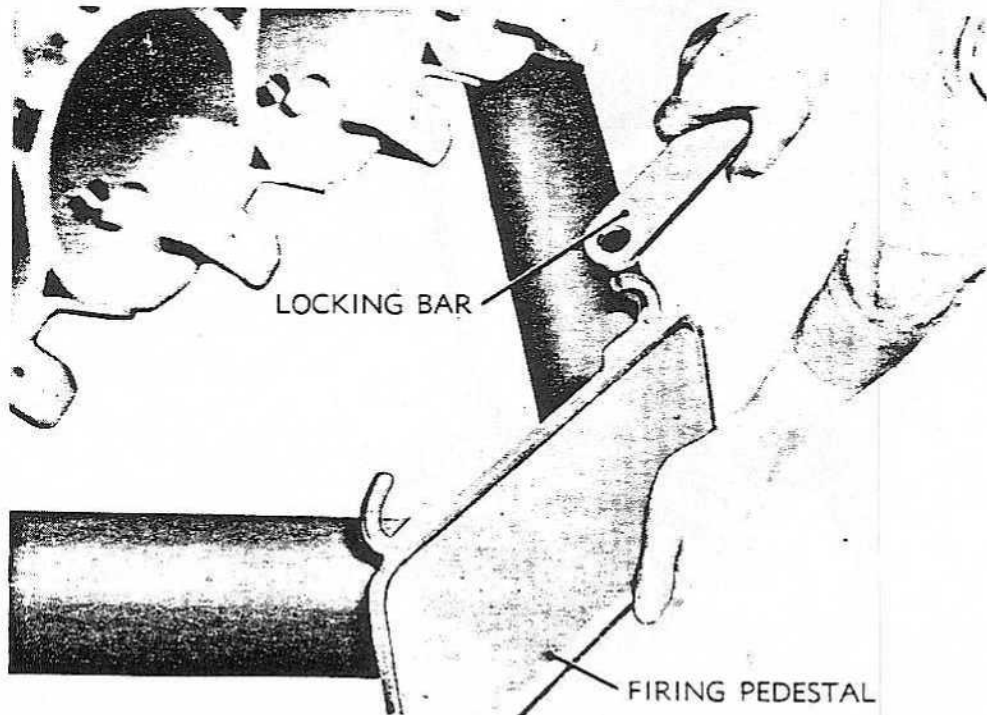

RA PD 104281

Figure 13—Releasing Firing Pedestal on Launcher T66

Part Two—Operating Instructions

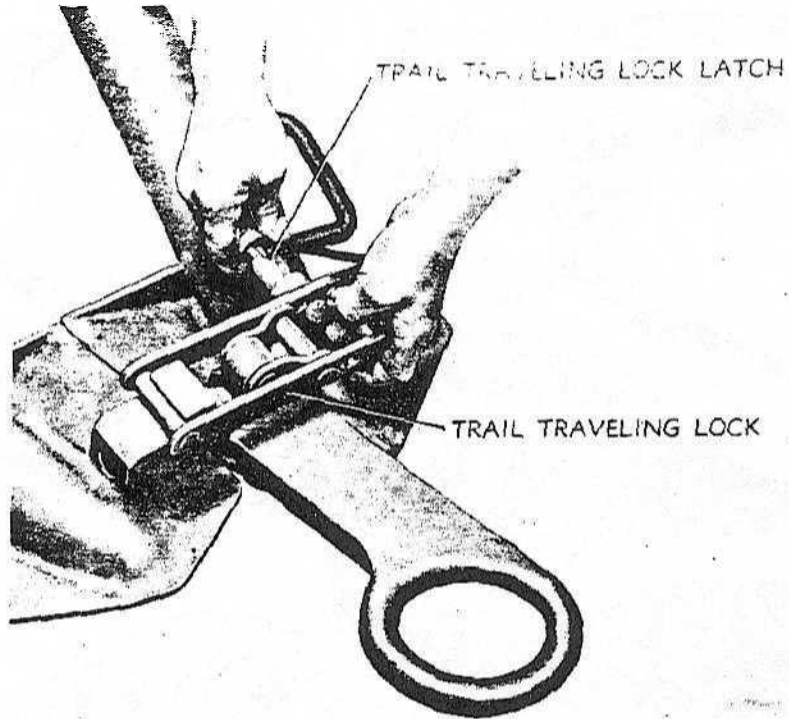

RA PD 104272

Figure 14—Releasing Trail Traveling Lock on Launcher T66

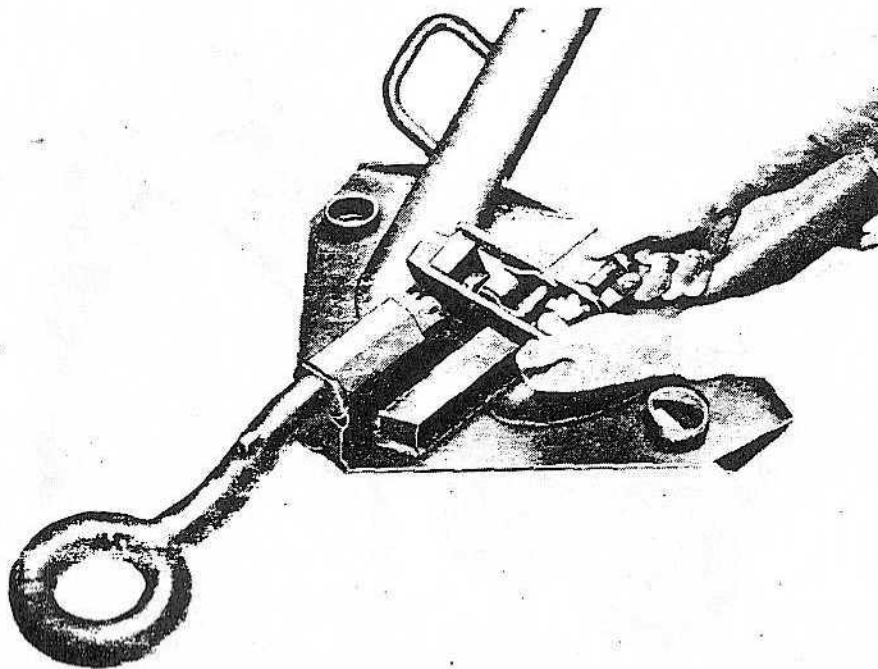

RA PD 104302

Figure 15—Releasing Trail Traveling Lock on Launcher T66E2

Part Two—Operating Instructions

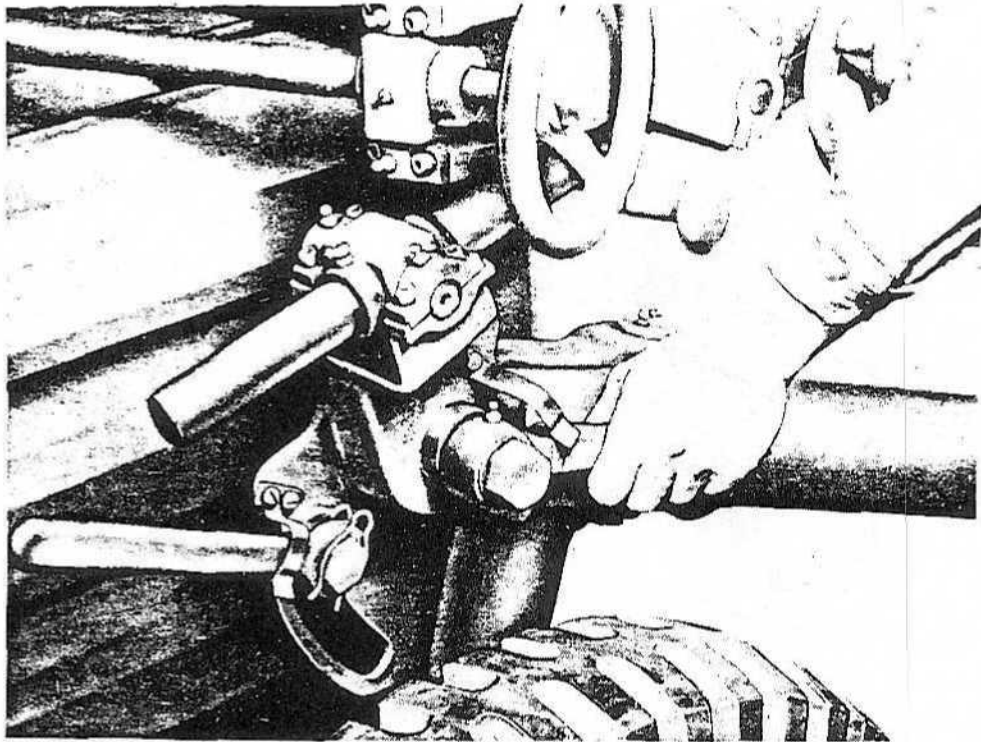

RA PD 104273

Figure 16—Tightening Trail Lock

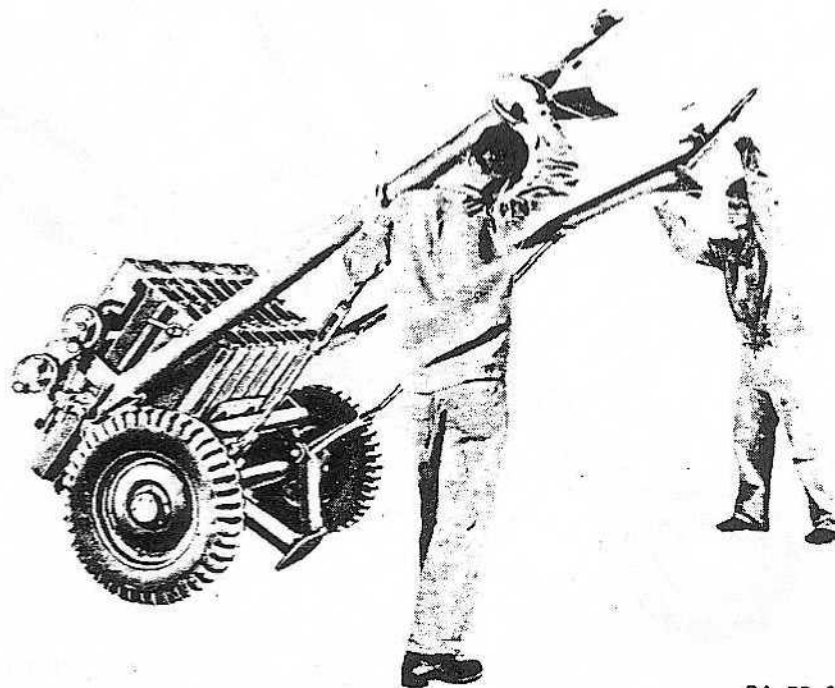

RA PD 104303

Figure 17—Tilting Launcher T66

Part Two—Operating Instructions

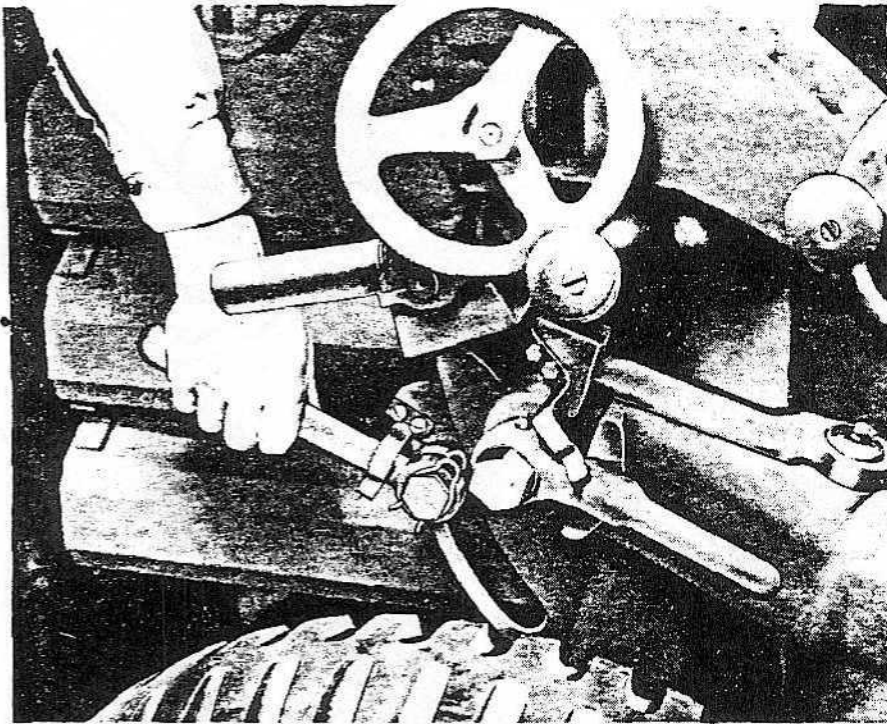

RA PD 104275

Figure 18—Releasing Elevating Lock

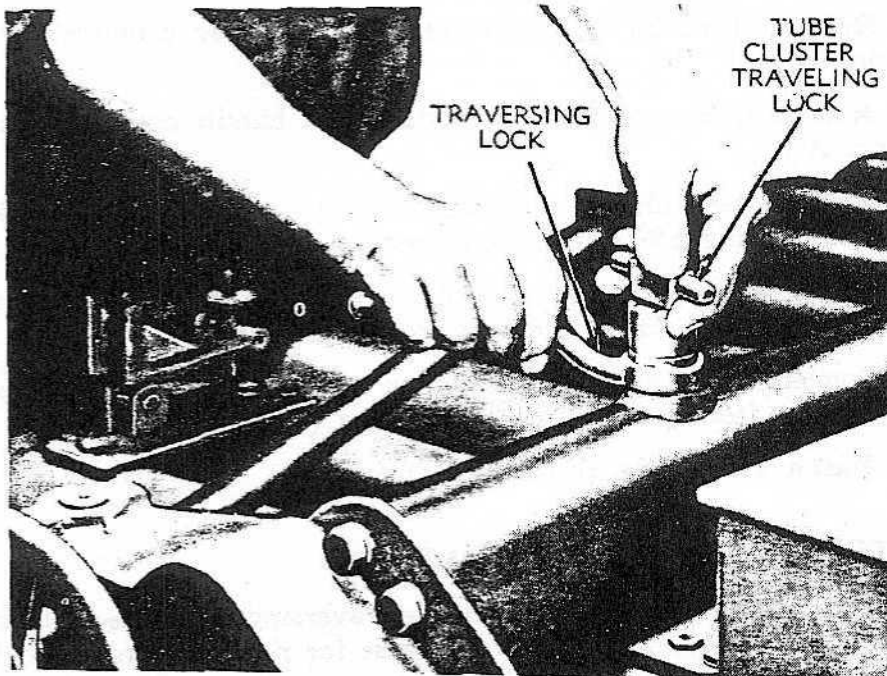

RA PD 104274

Figure 19—Releasing Traversing Lock

Part Two—Operating Instructions

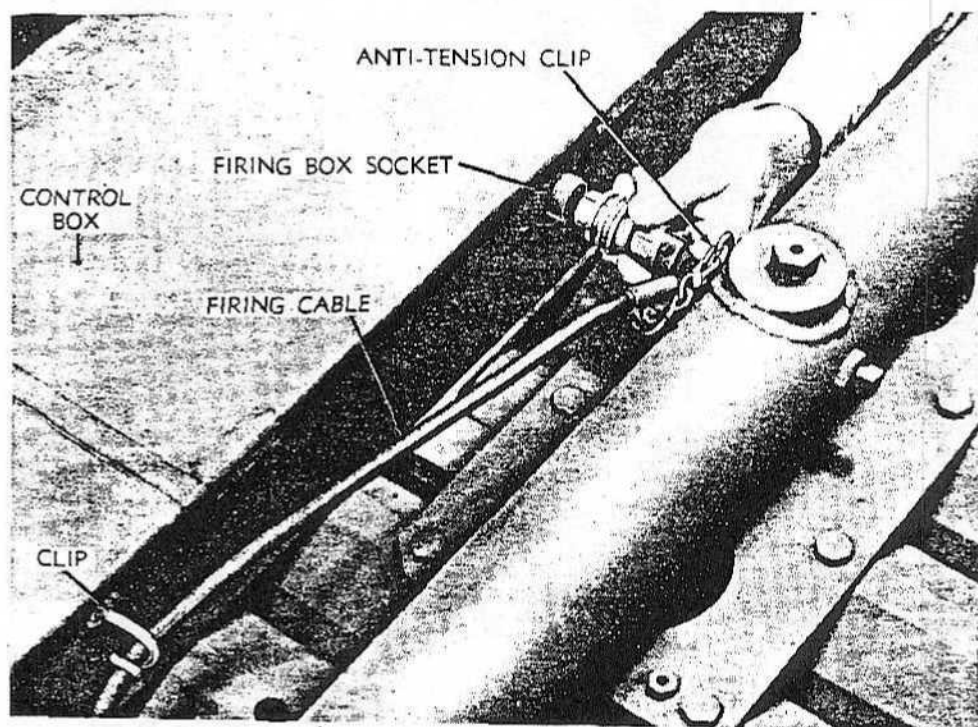

RA PD 104304

Figure 20—Connecting Firing Cable to Firing Box Socket

- f. Release elevating lock by rotating lock handle counterclockwise (fig. 18.)
- g. Release traversing lock by rotating lock handle counterclockwise (fig. 19).
- h. Release tube cluster traveling lock by pulling out the lock handle and rotating it 90 degrees in either direction (fig. 19).
- i. Install telescope mount and elbow telescope on sight bracket. Adjust cross-leveling screw to center cross-level bubble.
- j. Connect firing cable to firing box socket. This socket protrudes through front panel of the control box (fig. 20).
- k. Fasten antitension clip to eye (fig. 20).

21. TO TRAVERSE AND ELEVATE.

- a. Loosen traversing lock and rotate traversing handwheel clockwise for left traverse, and counterclockwise for right traverse. Lock in position before firing.
- b. Loosen elevating lock and rotate elevating handwheel. Tighten elevating lock before firing.

Part Two—Operating Instructions

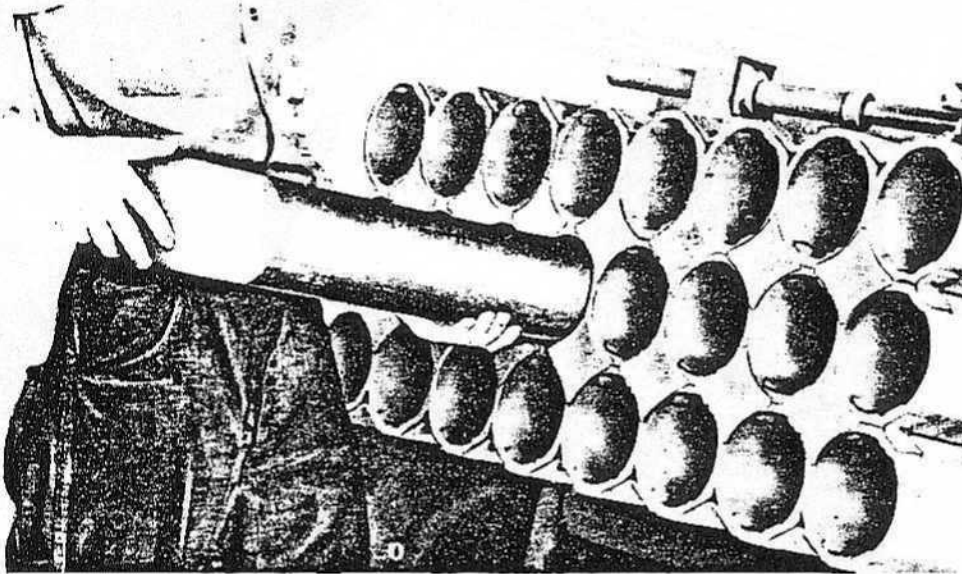

RA PD 104280

Figure 21—Loading Launcher

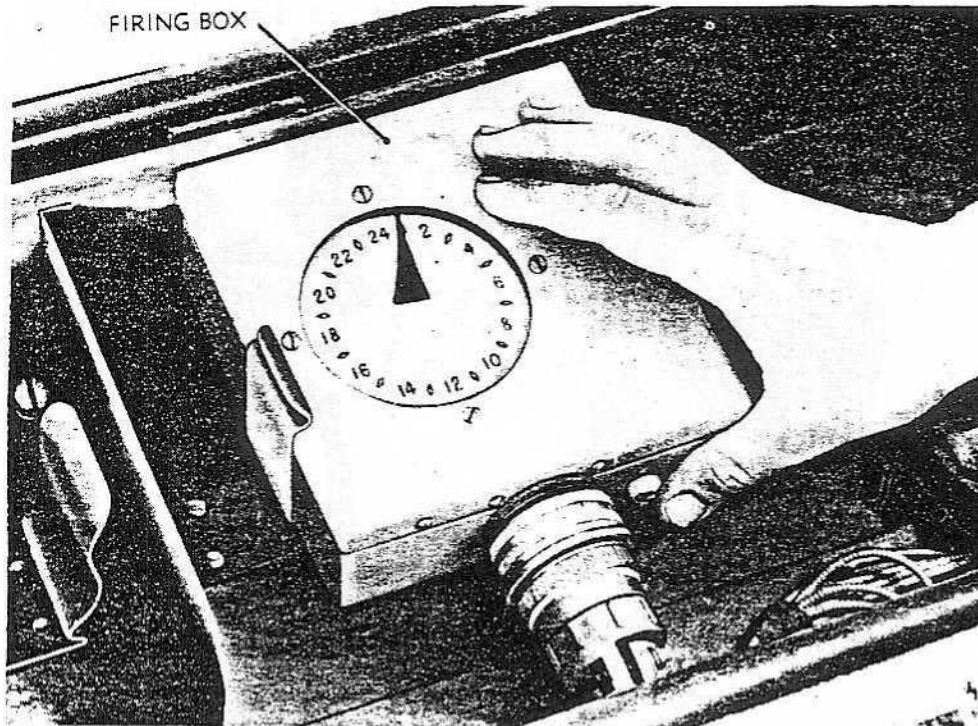

RA PD 104305

Figure 22—Indexing Indicator on Launcher T66

Part Two—Operating Instructions

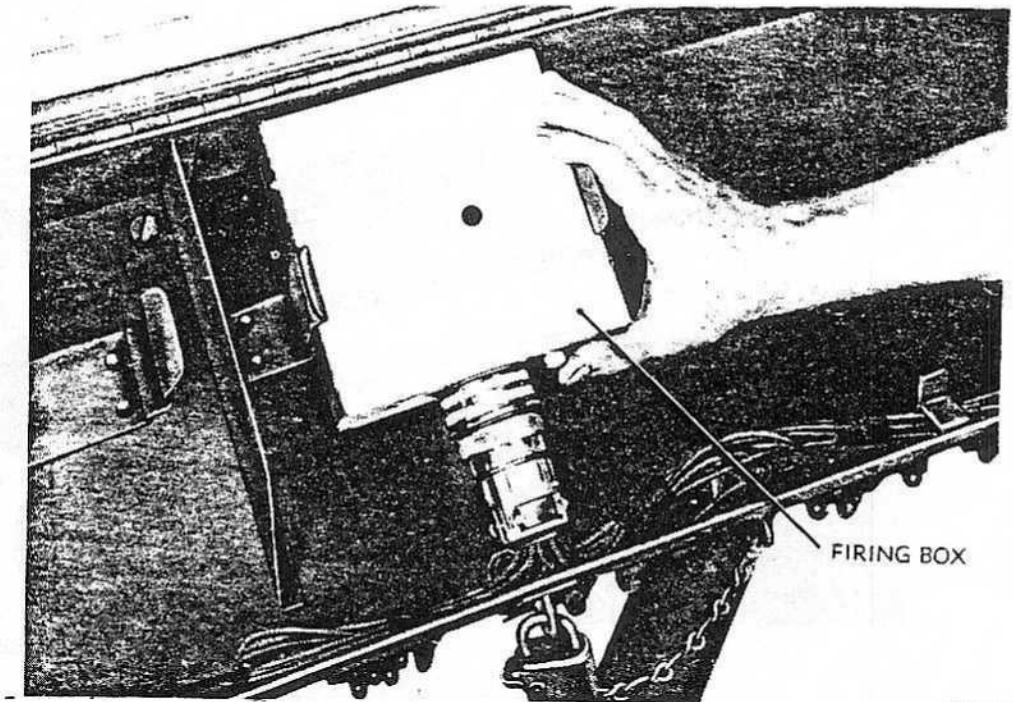

RA PD 104306

Figure 23—Indexing Indicator on Launcher T66E2

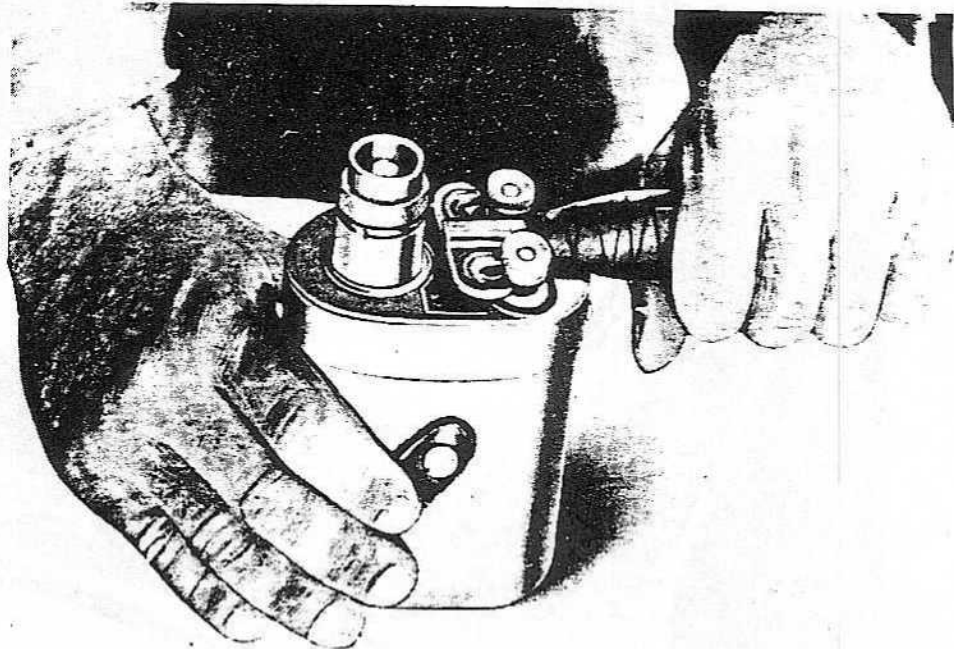

RA PD 104307

Figure 24—Connecting Firing Cable to Blasting Machine (Launcher T66)

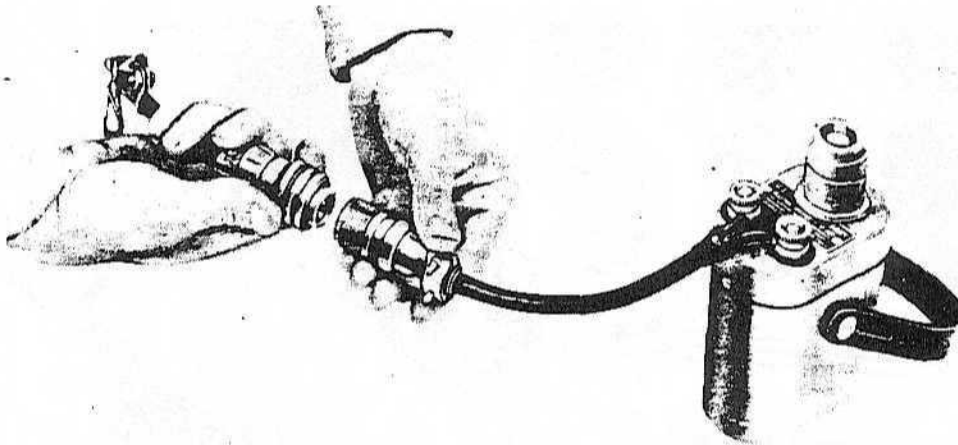
Part Two—Operating Instructions

RA PD 104308

**Figure 25—Connecting Firing Cable to Blasting Machine
(Launcher T66E2)**

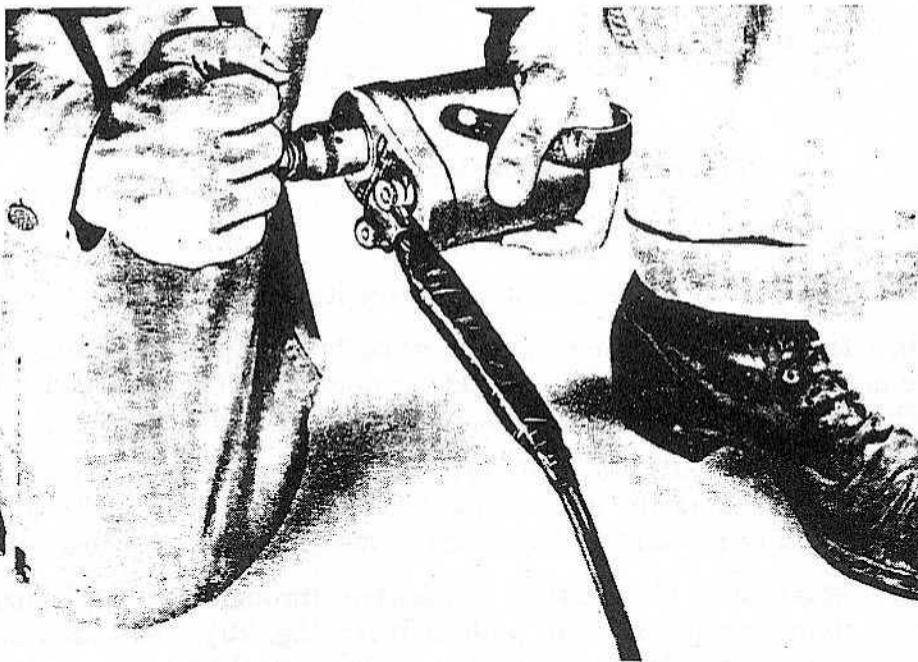

RA PD 104309

Figure 26—Firing

22. TO LOAD. *CAUTION: Before loading, be sure blasting machine is disconnected from firing cable. Loader should carry handle or preferably entire machine with him. Set rocket fuzes to "DELAY" or "SQ," as desired, and remove safety shorting strip from rockets. Insert rockets into muzzle of each tube, base first. Make sure the rocket seats against the stop at the rear of the tube (fig. 21).*

Part Two—Operating Instructions

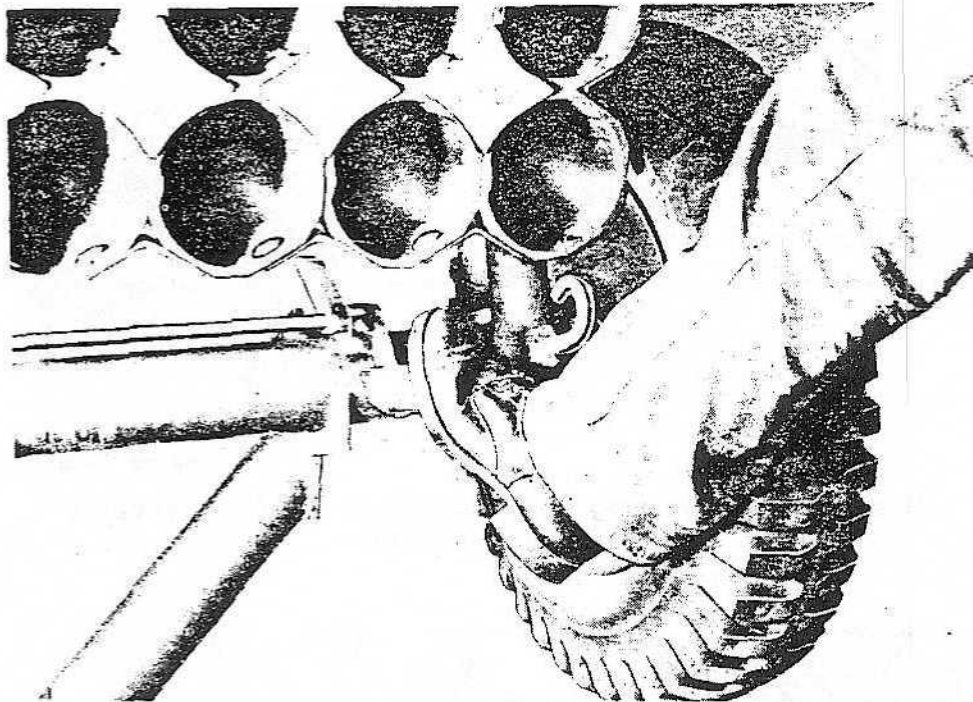

RA PD 104310

Figure 27—Releasing Pedestal Lock

23. TO FIRE.

- a. Remove telescope mount and place it in control box.
- b. If desired, index indicator on firing box by pushing button on side of box until the indicator is set on number 1 (figs. 22 and 23). (When exploder handle is turned, tube No. 1 will fire.)
- c. *Make sure all personnel are approximately 75 feet clear of the launcher and out of the path of the rocket blast. The person firing should be off to the side of the launcher, the length of the firing cable.*
- d. Make sure firing cable is inserted through clip on control box so that it cannot get into path of blast (fig. 20). An additional precaution is made by wrapping the cable several times around the trail lock handle.
- e. Connect firing cable to blasting machine (figs. 24 and 25). Hold the machine in the left hand, strap across the back of the hand, and insert firing handle.
- f. Grasp the firing handle with right hand, knuckles towards terminals of blasting machine, and twist the handle clockwise as rapidly as possible while twisting the machine in the opposite direction with the left hand (fig. 26). Since maximum current is generated

Part Two—Operating Instructions

only when handle is vigorously twisted all the way to stop, it is necessary to "follow through" with each twist. Short weak twists will not fire rockets, and, generally, will not index switch.

NOTE: One twist of the firing handle will fire one rocket at a time for single fire. For ripple fire, successive twists are necessary.

CAUTION: If any rocket fails to fire after blasting machine handle has been twisted, do not approach launcher. Continue to operate blasting machine until indicator has again passed rocket. For example, should No. 8 tube fail to fire, operate mechanism until indicator passes through No. 24 and then passes No. 8. If rocket still fails to fire, it must be considered a misfire. Round should then be allowed to remain in launcher at least 2 minutes after last attempt to fire it in order to avoid danger of a hangfire. After this, the misfired rocket should be removed from launcher by the loader, other personnel keeping at safe distance. Replace safety shorting strip and remove fuze from rocket. Return the rocket to ordnance personnel for disposition.

24. TO PLACE LAUNCHER IN TRAVELING POSITION.

- a. Remove telescope mount and telescope. With tube cluster in dead center of launcher, engage the tube cluster traveling lock.
- b. Engage traversing lock.
- c. With tube cluster at zero-degree elevation, engage elevating lock.
- d. Tilt launcher forward. Press pedestal lock to release firing pedestal (fig. 27). Push launcher off firing pedestal onto wheels and lower trails to ground.
- e. Release trail locks, close trails, and engage trail traveling lock.
- f. Hook pedestal locking bars to pedestal and tighten up on locking bar latches.
- g. Replace cover.

Section VIII

OPERATION OF AUXILIARY EQUIPMENT

25. **GENERAL.** Operation of on-carriage instruments is described in section XXVII.

Part Two—Operating Instructions

Section IX**OPERATION UNDER UNUSUAL CONDITIONS****26. GENERAL.**

- a. Since rockets may not be fired outside their temperature ranges, operation under extreme temperature conditions is not permitted.
- b. Refer to section XII for lubrication under unusual conditions.

27. EXCESSIVELY MOIST OR SALTY ATMOSPHERE.

- a. When the materiel is not in active use, the unpainted metal parts should be covered with a film of rust-preventive compound (light). The bore of the metal tubes should be kept oiled and all parts should be inspected daily for traces of the formation of rust. The materiel should be kept covered with tarpaulins as much as possible.
- b. In excessively salty atmosphere, the oil or rust-preventive compound (light) used should be changed often, as the salt has a tendency to emulsify the oil and destroy its rust-preventive qualities.
- c. Check carriage frequently for chipped or cracked paint.

28. EXCESSIVELY SANDY OR DUSTY CONDITIONS.

- a. If considerable sand or dust is present when the launchers are operated, the lubricant should be removed from the moving parts and these parts should remain dry until the action is over. If the surfaces are dry, there is less wear than when coated with a lubricant contaminated with grit.
- b. Keep materiel covered with tarpaulins as much as possible.
- c. Materiel must be cleaned frequently, as sand or dust and lubricant act as an abrasive.

29. COLD CLIMATES WITHIN TEMPERATURE RANGES.

- a. Preparing a weapon for cold climate consists of inspecting and placing the launcher in good mechanical condition, cleaning, and lubricating with cold-weather lubricants, and frequent exercising.
- b. The materiel should be inspected to see that all moving parts operate freely and without binding.
- c. In cold climates it is essential that all moving parts be kept absolutely free of moisture.

Part Two—Operating Instructions

d. Clean and lubricate all parts, but do not use excess lubricant, because it may solidify to such an extent as to cause sluggish movement.

e. When launchers are in the open, cover with tarpaulins or other suitable material, if possible.

f. When tube cluster and carriage are transferred from the outside into a heated building, wipe dry with clean cloths, and clean and oil metal parts immediately to prevent condensation of moisture.

g. Before applying the cold-weather lubricants, the materiel should be thoroughly cleaned and all old lubricants removed.

h. Tube cleaning.

(1) **RIFLE BORE CLEANER.** When cleaning the inside of the tubes with rifle-bore cleaner at temperatures below 0°F, wipe the tubes dry and oil. Do not allow the rifle-bore cleaner to remain in the tubes as freezing of the cleaner in the tubes may make firing dangerous. The third day after firing, use dry-cleaning solvent, if available, to remove the old film. When rifle-bore cleaner can no longer be used due to freezing, the tubes must either be warmed before continuing to use the bore cleaner or a soda-ash or soap-solution must be used. *Do not add antifreezes to rifle-bore cleaner.*

(2) **SODA-ASH OR SOAP SOLUTION.** When using soda-ash or soap solution, the cleaning of cold tubes after firing cannot be accomplished in the normal manner at temperatures below +32°F. because the water will freeze in the tubes. If cleaning can be done while the tubes are hot and hot water is available, soda-ash or issue soap solution will be used. Otherwise, it will be necessary to add denatured alcohol, or an emergency substitute (glycerine, or antifreeze compound (ethylene glycol type)) to the solution. To 10 parts by volume of cleaning solution (water and soda-ash or soap), add the number of parts of one of the antifreezes indicated below:

Temperatures (degrees F)	Alcohol	or	Glycerine	or	Antifreeze Compound
20	2		2½		2
10	4		5		3½
0	6½		6½		5
-15	9		10		7¼
-30	16		13		10
-40	27		16		12

(3) In applying light or special preservative lubrication oil to the tubes after cleaning, work the oil in carefully so that it will reach all surfaces. When the launcher, after being exposed to low temperatures, is brought into a heated shop, condensation will occur on all metal surfaces. After the launcher reaches room temperature, the tubes and all other bright parts must be dried and recoated with oil to prevent rusting.

Part Two—Operating Instructions

(4) After firing, the tubes will be cleaned with bore cleaning solution on 3 consecutive days thereafter, or longer if sweating continues, then dried, and oiled.

(5) During periods when the materiel is not fired, the oil film will be renewed daily by swabbing with burlap saturated with oil. Every 5 days, swab with dry-cleaning solvent, dry, and renew the oil film.

30. HOT CLIMATE WITHIN TEMPERATURE RANGES.

a. In hot climates, inspect and clean the launcher as frequently as required, rather than at fixed intervals.

b. Where humidity is high, clean and oil as soon as possible after firing, when the launcher gets wet or dirty, or if there is any reason to expect corrosion to start.

c. In temperatures above 90°F, summer grade greases and oils should be used as lubricants.

Section X

DEMOLITION TO PREVENT ENEMY USE

31. GENERAL.

a. The destruction of the materiel when subject to capture or abandonment in the combat zone will be undertaken by the using arm, only on authority delegated by the division or higher commander as a command function when such action is deemed necessary as a final resort to keep the materiel from reaching enemy hands.

b. Adequate destruction of artillery materiel means damaging it in such a way that the enemy cannot restore it to usable condition in the combat zone either by repair or by cannibalization. Adequate destruction requires that:

(1) Enough parts essential to the operation of the materiel must be damaged.

(2) Parts must be damaged beyond repair in the combat zone.

(3) The same parts must be destroyed on all materiel, so that the enemy cannot make up one operating unit by assembling parts from several partly destroyed units.

c. The tubes are the most vital parts of these weapons. These are the first things to damage.

Part Two—Operating Instructions

32. DEMOLITION OF LAUNCHERS T66 AND T66E2.

a. Detach the sight. If evacuation is possible, carry the sight. If not, smash the sight thoroughly.

b. Insert one incendiary grenade M14 midway in the center tube at zero-degree elevation. Ignite this grenade by inserting one other grenade, equipped with a 15-second safety fuze. Take cover, as the danger zone is at least 100 yards.

33. DEMOLITION OF AMMUNITION. Demolition of ammunition is covered in TM 9-1901.

PART THREE—MAINTENANCE INSTRUCTIONS

Section XI

GENERAL

34. **SCOPE.** Part Three contains information for the guidance of the personnel of the using organizations responsible for the maintenance (first- and second-echelon) of this equipment. It contains information needed for the performance of the scheduled lubrication and preventive maintenance services as well, as a description of the major systems and units and their functions in relation to other components of the equipment.

35. **CLEANING AND PRESERVING MATERIALS.** The following cleaners and preservatives are issued for use with this materiel (see SNL K-1 and TM 9-850 for detailed information):

BURLAP, jute
CLEANER, rifle-bore
CLOTH, crocus
CLOTH, wiping, cotton
GREASE, O.D.
OIL, engine
OIL, preservative lubricating (special)
SODA-ASH
SOLVENT, dry-cleaning

Section XII

LUBRICATION

36. **LUBRICATION ORDER.**

a. Reproduction of War Department Lubrication Order LO 9-392 (fig. 28) prescribes first- and second-echelon lubrication maintenance.

b. The lubricating fittings indicated on the order are illustrated in figures 29 to 33, showing their location on the materiel. The fittings shown in the figures may be identified on the order by the key numbers around the border.

c. A lubrication order (formerly War Department Lubrication Guide) is placed on or is issued with each item of materiel and is to

**Figure 28—War Department Lubrication Order LO 9-392
(to be inserted when available)**

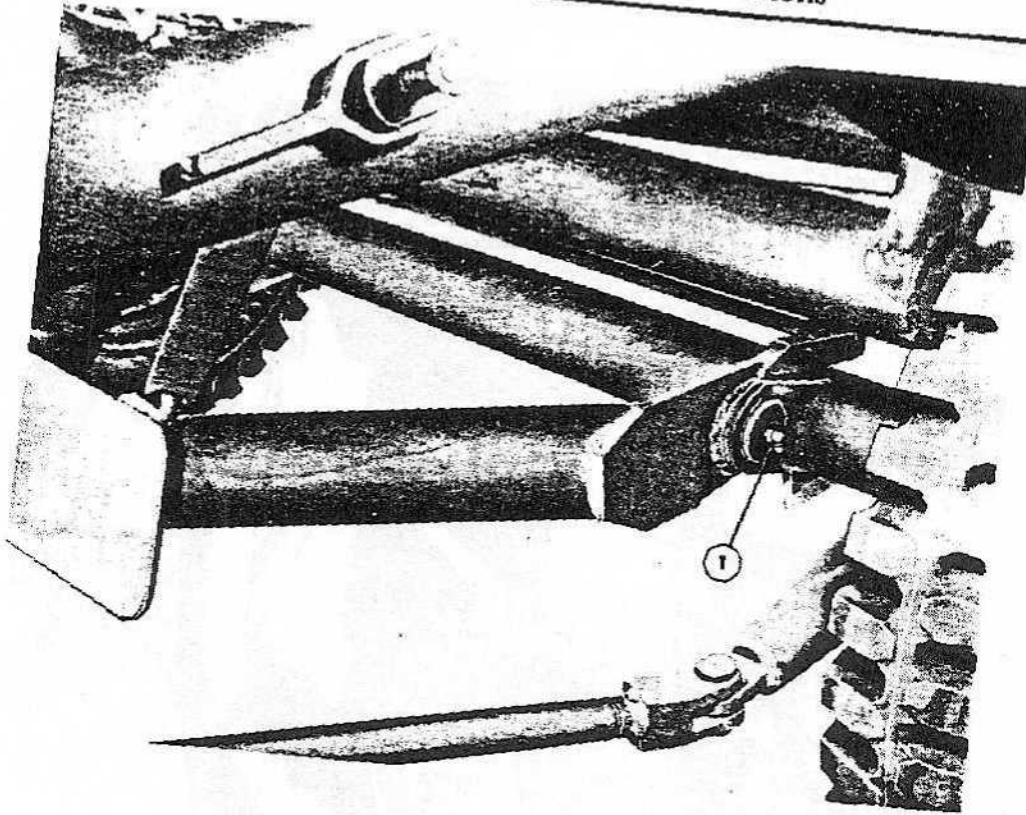

Figure 29—Lubrication Point No. 1

RA PD 104311

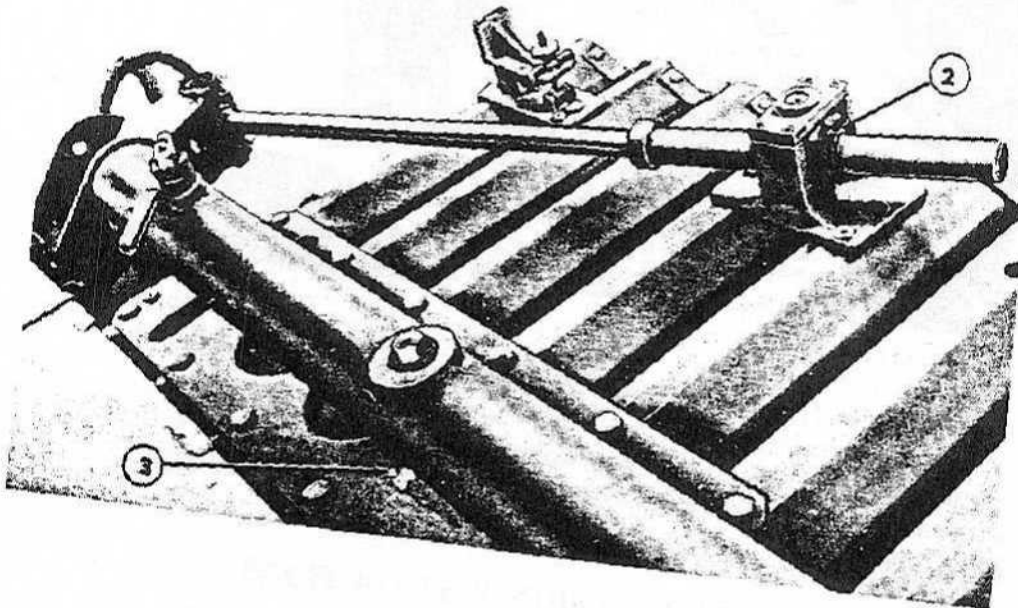
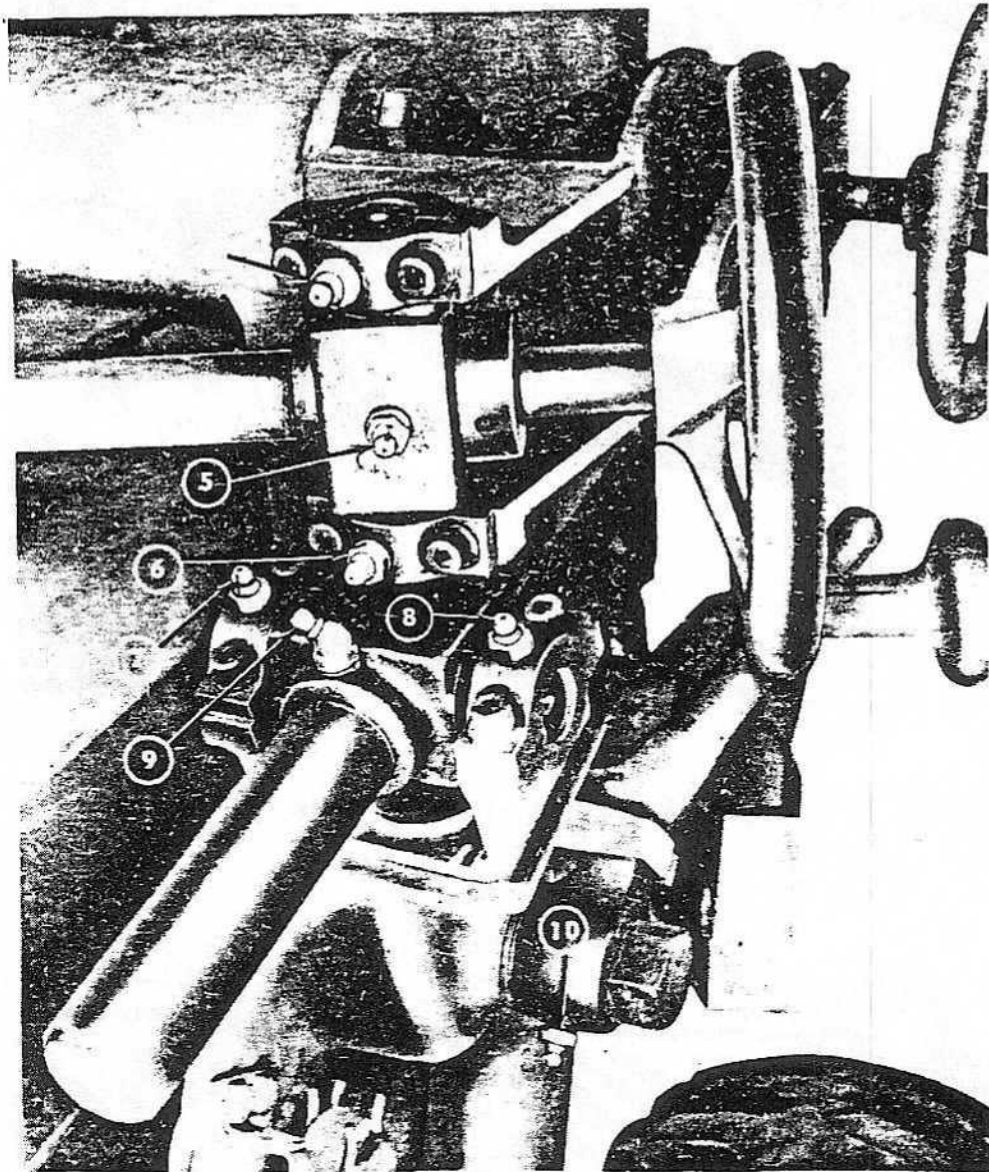

Figure 30—Lubrication Points Nos. 2 and 3

RA PD 104312

Part Three—Maintenance Instructions

RA PD 104313

Figure 31—Lubrication Points Nos. 4 to 10 Inclusive

be carried with it at all times. In the event the materiel is received without an order, a replacement should be immediately requisitioned (FM 21-6).

37. GENERAL LUBRICATION INSTRUCTIONS.

a. **Lubricants.** Lubricants are prescribed in the "Key" on the Lubrication Order in accordance with three temperature ranges: "above +32° F," "from +32° F to 0° F," and "below 0° F." The time

Part Three—Maintenance Instructions

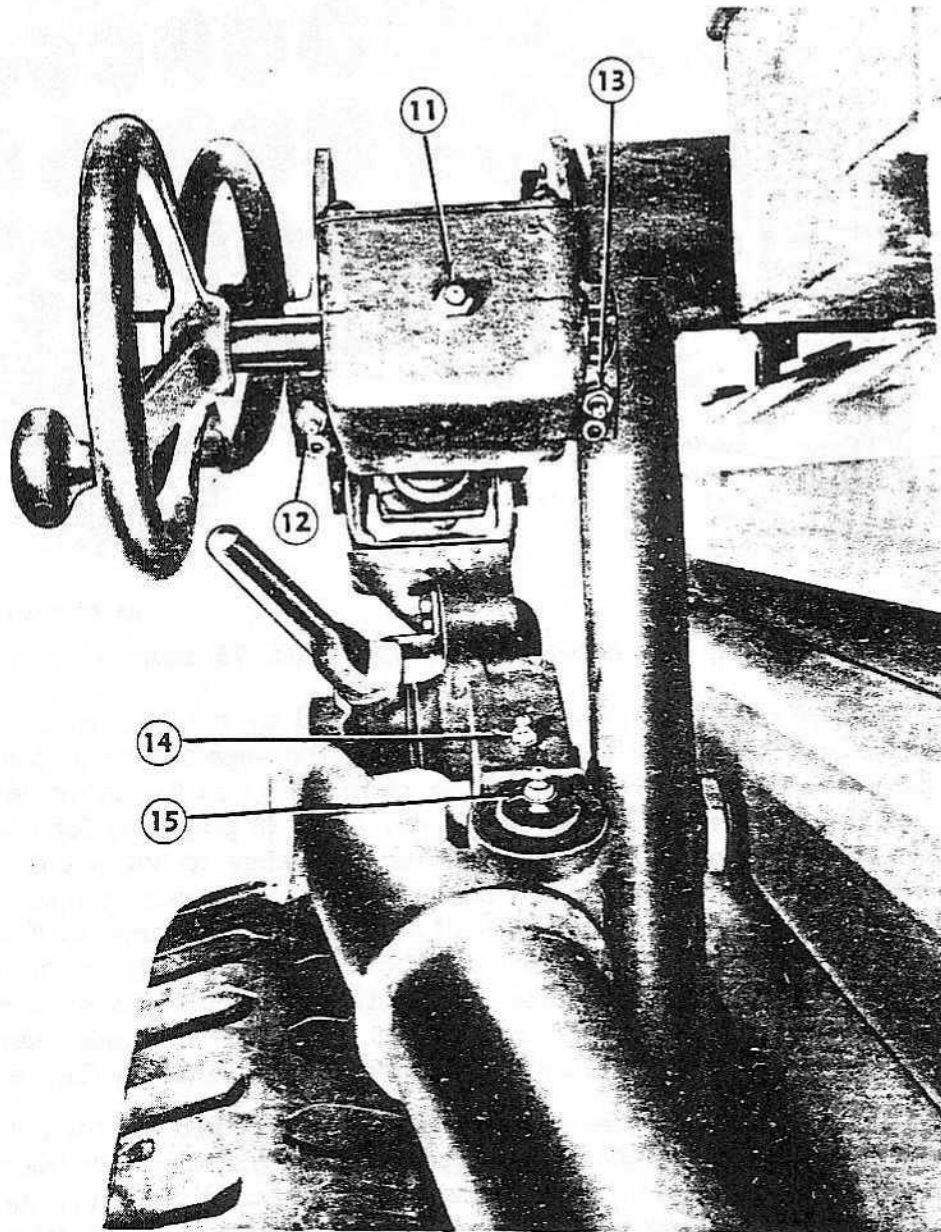

RA PD 104314

Figure 32—Lubrication Points Nos. 11 to 15 Inclusive

Part Three—Maintenance Instructions

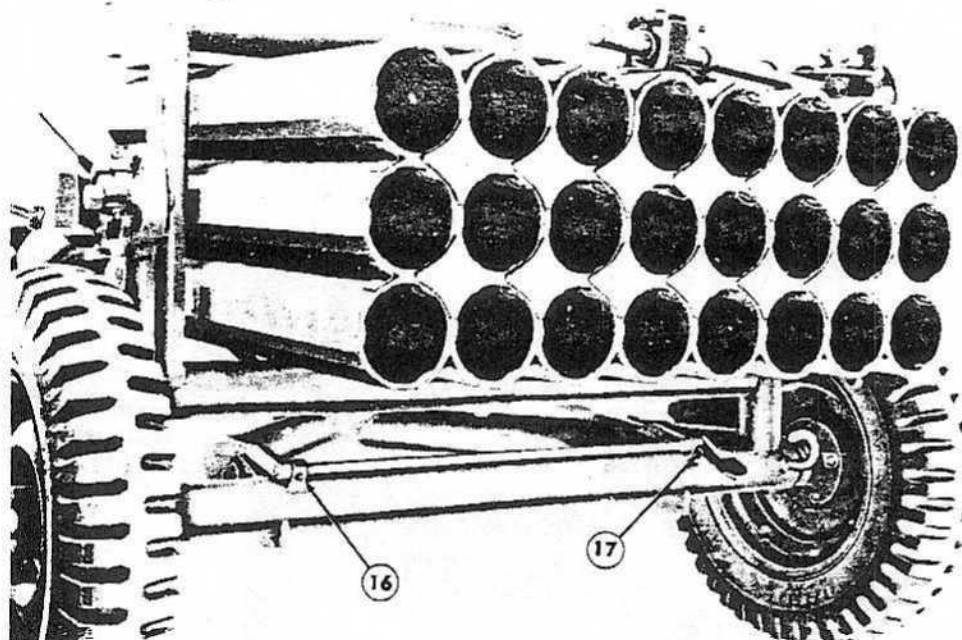

RA PD 164315

Figure 33—Lubrication Points Nos. 16 and 17

to change grades of lubricants is determined by maintaining a close check on operation of the materiel during the approach to prolonged periods when temperatures will be consistently in higher or lower ranges. Because of the time element involved in preparing for operation at lower prevailing temperatures, a change to lubricants prescribed for a lower range will be undertaken the moment operation becomes sluggish. Ordinarily, it will be necessary to change lubricants *only when expected air temperatures will be consistently in the next higher or lower range*, unless malfunctioning occurs sooner due to lubricants being of improper consistency. **NOTE:** *Seasonal changes of lubricants and recoil oils will be recorded in the Artillery Gun Book.*

b. **Service intervals.** Service intervals specified are for normal operating conditions and continuous use of the materiel with frequent firing. Reduce these intervals under extreme conditions such as excessively high or low temperatures, prolonged periods of traveling or firing, continued operation in sand or dust, immersion in water, or exposure to moisture. Any one of these conditions may quickly destroy the protective qualities of the lubricant, and require servicing in order to prevent malfunctioning or damage to the materiel.

c. **Lubricating equipment.**

(1) Be sure to clean lubricating equipment both before and after use. Operate lubricating guns carefully and in such manner as to

Part Three—Maintenance Instructions

insure proper distribution of the lubricant. If lubrication fitting valves stick and prevent the entrance of lubricant, remove the fitting and determine cause. Replace broken or damaged lubricators. If lubricator cannot be replaced immediately, cover hole with tape as a temporary expedient to prevent the entrance of dirt. If oil lines become clogged, disassemble the line and remove the obstruction.

(2) Lubrication fittings, grease cups, oilers, oil holes, and plugs are circled in red for ready identification.

(3) Wipe lubricators and surrounding surfaces clean before applying lubricant. Where relief valves are provided, apply new lubricant until the old lubricant is forced from the vent. Exceptions are specified in notes or on the Lubrication Order. Metal surfaces on which a film of lubricant must be maintained by manual application, will always be wiped clean before the film is renewed.

d. Cleaning.

(1) Unless otherwise specified, use rifle-bore cleaner or dry-cleaning solvent to clean or wash all metal parts, whenever partial or total disassembly is undertaken, or when renewing the protective lubricant film on exposed metal surfaces. Flushing of gear cases and bearing housings will not be undertaken unless inclosed mechanism is first disassembled in order to insure complete removal of the cleaner or solvent prior to the application of lubricants. Use of gasoline for cleaning is prohibited. Dry all parts thoroughly before lubricating.

(2) Care must be taken when cleaning oil and grease compartments to insure the complete removal of all residue or sediment. Dirt or other foreign matter should not be allowed to drop into any of the lubricating compartments.

e. Lubrication.

(1) Fill elevating and traversing mechanisms with O.D. grease No. 0 above +32° F or No. 00 below +32° F, monthly.

(2) The wheel bearings should be removed at 6-month intervals for lubrication with general purpose grease No. 2.

(3) Lubricate other bearings equipped with lubrication fittings with O.D. grease No. 0 above +32° F or No. 00 below +32° F, monthly.

(4) Clean all unpainted metal surfaces, latches, and linkages of the carriage daily, and oil with engine oil SAE 30 above +32° F or SAE 10 between 32° F and 0° F, or preservative lubricating oil (special) below 0° F.

 Part Three—Maintenance Instructions

Section XIII

PREVENTIVE MAINTENANCE SERVICE

38. GENERAL.

a. **Scope.** Preventive maintenance services prescribed by Army Regulations are a function of using-organization echelons of maintenance. This section contains preventive maintenance service allocated to crew and scheduled preventive maintenance service allocated to (second echelon) organizational maintenance.

b. **Cleanliness.** Dirt or grit, accumulated in traveling or from blast of piece in firing, settles on bearing surfaces and forms a cutting compound. Powder fouling attracts moisture and settles in operating grooves, preventing proper operation of moving parts, and hastens the formation of rust. It is essential that all parts be cleaned at frequent intervals, depending upon use and service.

c. **Rust removal.** If rust should accumulate, its removal from bearing surfaces requires special care in order that clearance shall not be unduly increased. *Crocus cloth* should be used for this purpose. The use of coarse abrasives is strictly forbidden.

d. **Care.** When materiel is not in use, suitable tarpaulins should be used as covers. When materiel is not to be used for considerable time, all bright unpainted metal surfaces should be cleaned with dry-cleaning solvent and coated with rust-preventive compound.

39. PREVENTIVE MAINTENANCE SCHEDULES.

Point	Preventive Maintenance	Detailed Instructions
a. Before firing.		
Tube cluster	Clean and dry.	Par. 42 a
b. After firing.		
Tube cluster	Clean and oil.	Par. 37 d
Firing cable	Clean.	Par. 42 e
c. Daily service.		
Tube cluster	Clean and oil.	Par. 42 c
d. If used in wet weather.		
Contact fingers and exposed wires	Dry.	Par. 42 d

Part Three—Maintenance Instructions

Section XIV**MALFUNCTIONS AND CORRECTIONS****40. FAILURE TO FIRE.**

a. Contacts may become rusted or corroded. Clean them with crocus cloth.

b. Live contact is insulated from tube by air space. Should these contacts be damaged so that they touch the tube, contact will be shorted and rocket will not fire. The contacts may be adjusted by bending them slightly up or down. Contact may be replaced completely using the wrench provided.

c. If couplings on firing cable are damaged or broken, a temporary repair may be made until the ordnance maintenance personnel are notified.

d. Check the insulation bead on the wires. If damaged, remove terminal screw, remove damaged bead, and insert new one, then replace terminal screw (figs. 34 and 35).

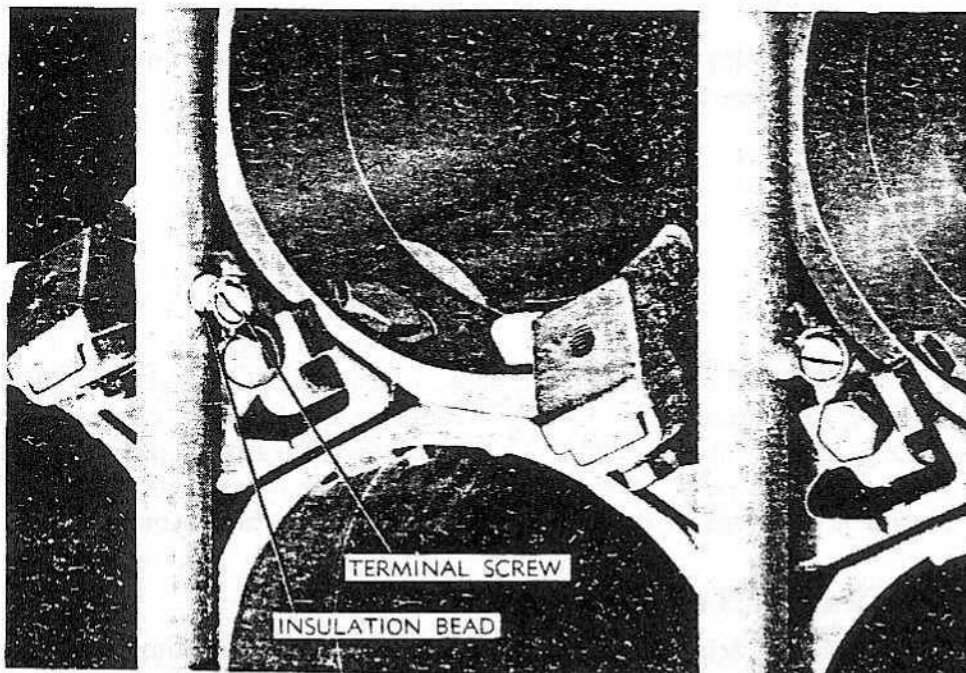

RA PD 104316

Figure 34—Insulation Bead on Launcher T66

Part Three—Maintenance Instructions

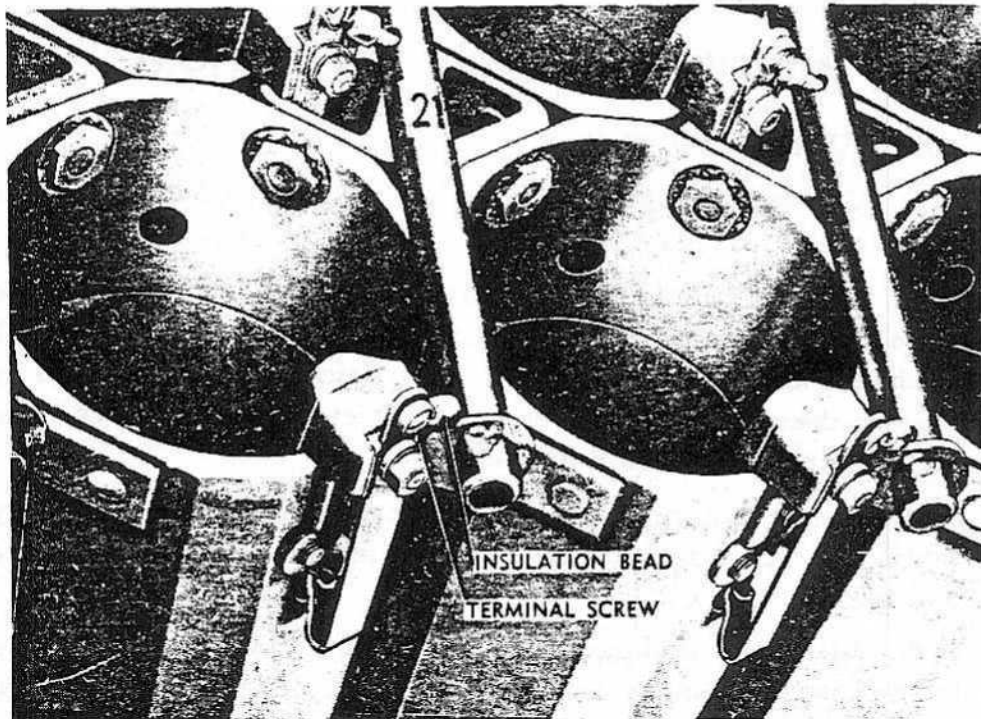

RA PD 104317

Figure 35—Insulation Bead on Launcher T66E2

- e. On T66E2 launcher, check Amphanol plug connection from blasting machine to cable.

Section XV

TUBE CLUSTER

41. **GENERAL.** The tube cluster, consisting of 24 tubes, is bound together as a unit and pivots horizontally in the tube cluster frame during traverse of the piece. The tube cluster frame is provided with trunnions and rests in the side frames of the carriage. The tube cluster is elevated or depressed by the elevating mechanism.

42. MAINTENANCE OF TUBE CLUSTER.

- a. Before firing remove all rust-preventive compound from the holding assembly and contact fingers, using rifle-bore cleaner and clean dry burlap or wiping cloths. Before loading, wipe the inside of the tubes with clean, dry burlap or wiping cloths to insure that the tubes are *clean and dry*.

Part Three—Maintenance Instructions

b. After firing, clean and oil the inside of the tubes as prescribed in paragraph 37 d.

c. When not being fired, wipe tubes clean daily and renew the oil film. To remove gummy deposits of congealed oil, swab with dry-cleaning solvent, wipe thoroughly dry, and reoil. A cleaning staff is issued with the launcher.

d. If the launcher has been used in wet weather, dry all electric contact points and exposed wires with a dry cloth. Clean and oil the rest of the launcher as described above.

e. After firing, wipe the firing cable clean of any dirt, grease, or foreign material, using clean, dry burlap or wiping cloths.

f. **Bore cleaning and preservation.** The following materials and cleaning and preserving procedures will be used for the inside of the tubes in order of indicated preference. Oils to be applied after cleaning will be the same as prescribed by applicable War Department Lubrication Orders and Technical Manuals for specific temperature ranges.

(1) **RIFLE-BORE CLEANER.**

(a) After firing, and on two consecutive days thereafter, thoroughly clean the inside of the tubes with rifle-bore cleaner making sure that all surfaces are well coated. Do not wipe dry.

(b) On the third day after firing, clean the inside of the tubes with rifle-bore cleaner. If the piece will probably be fired within the next 24 hours, do not wipe dry. If the piece will not be fired within the next 24 hours, wipe dry and coat with the prescribed oil.

(c) After the third day since firing, renew the oil film daily. Every fifth day, clean with rifle-bore cleaner, wipe dry, and reoil.

(2) **SODA-ASH.**

(a) Prepare a solution of one-half pound soda-ash to each gallon of warm water. In temperatures below +32° F, add the type and amount of antifreeze prescribed in TM 9-850, if the tubes to be cleaned are cold.

(b) Immediately after firing and on three consecutive days thereafter, thoroughly clean the tubes with the soda-ash solution. Rinse with clean warm water and wipe dry. Coat with the prescribed oil.

(c) When the piece is not being fired, renew the oil film daily. Every fifth day, clean the tubes with dry-cleaning solvent or rifle-bore cleaner, if available. Wipe dry and reoil.

(3) **SOAP.**

(a) Use castile soap or issue soap.

(b) Prepare a sponging solution by shaving one pound of soap into four gallons of water. If possible, warm the water to facilitate dissolving the soap. In temperatures below +32° F, add the type

Part Three—Maintenance Instructions

and amount of antifreeze prescribed in TM 9-850, if the tube to be cleaned is cold.

(c) Follow the same cleaning, drying, and oiling procedure prescribed for the soda-ash solution.

CAUTION: *When issue soap is used, the tubes must be thoroughly rinsed after cleaning as the soap may contain free caustic which will cause corrosion if it is not completely removed.*

(4) **HOT WATER.**

(a) As a temporary measure after firing, the tubes may be cleaned while still hot by swabbing with quantities of hot water. This method will be used only when rifle-bore cleaner, soda-ash, or soap are not available. Extreme care must be taken to thoroughly dry the tubes after cleaning with hot water. A coating of oil will be applied immediately thereafter, to prevent rusting.

(b) Swabbing with hot water may not remove all of the primer salts or powder residue. It is most important, therefore, that the tubes be cleaned as soon as possible in accordance with paragraph 37 a, b, or c.

Section XVI

FIRING MECHANISM

43. GENERAL.

a. The firing mechanism is a ten-cap blasting machine (fig. 9). It is used as a source of electricity for firing the rocket from the launchers T66 and T66E2.

b. This machine is a small portable dynamo or magneto which weighs about five pounds. Two terminals are located on the upper surface of the body of the exploder. The exploder is operated by twisting the handle. The quicker the twist, the more current generated. The firing handle of this machine is removable. It should be detached from the machine until the rockets are ready to be fired.

c. The exploder can be connected to the firing box by the detachable firing cable which leads to the firing box (on the T66E2 launcher, the Amphanol plug connection is made) (fig. 20). Prior

Part Three—Maintenance Instructions

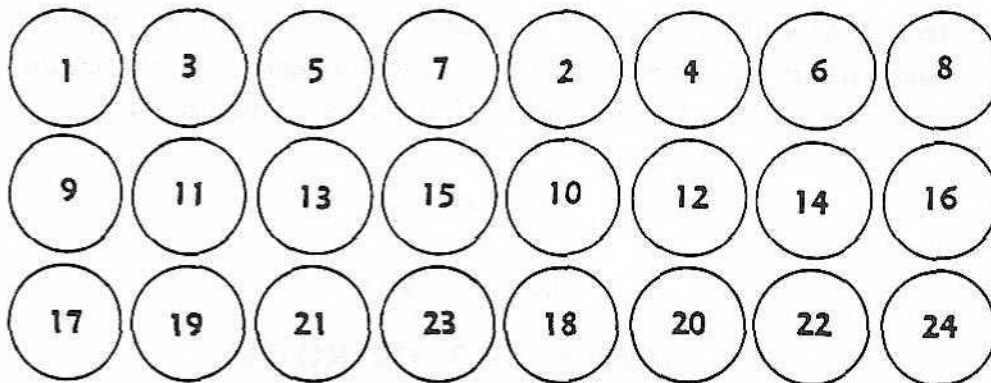

RA PD 104276

Figure 36—Firing Order of Tubes—Tube Cluster—Rear View

to firing, the box may be indexed to starting position (or any other position desired) by manually pushing button on side of box (with the blasting machine disconnected). The indicator may be used as a counter and as an indication of the tubes to be fired by setting the dial to No. 1. Each time the blasting machine is operated to fire a rocket, the indicator moves one position on the dial. The firing order of the tubes in the cluster is indicated in figure 36.

44. MAINTENANCE OF FIRING MECHANISM.

a. If the voltage weakens through lack of use, connect the terminals with a short piece of wire and twist the firing handle vigorously several times. Then remove the short piece of wire.

b. These exploders are issued with the launcher. They are also issued by the engineers, and replacements may be obtained from them if not otherwise available. Exploders should be returned to engineer personnel for adjustment and repair. Prior to turning in blasting machine from T66E2 launcher for replacement, the cable connection with Amphanol plug should be removed.

Section XVII

CARRIAGE

45. **GENERAL.** The carriage is a welded unit, consisting of two side frames welded to an axle which supports the wheel spindles. The side frames support the tube cluster frame.

Part Three—Maintenance Instructions

46. **MAINTENANCE OF CARRIAGE.** Maintenance of the carriage consists of lubricating latches and linkages, and lubricating all points equipped with lubricating fittings (see section XII).

Section XVIII**TRAILS AND TIE RODS**

47. **GENERAL.** The trails of the T66 launcher are welded assemblies which consist of the trail body, spades, and lunette. The trails of the T66E2 launcher are welded assemblies consisting of the trail body and spades. A detachable lunette is provided at the spade end of the trails. The trails of both launchers are hinged to the carriage side frames. Trail locks are located on the sides of the carriage. A trail traveling lock is provided on the back end of the trails. Tie rods, which are provided to support the trails, are fastened to the middle portion of the trails and to brackets on the axle of the carriage (fig. 3).

48. MAINTENANCE OF THE TRAILS AND TIE RODS.

a. If the lunette on the T66E2 launcher is damaged, it may be replaced.

b. The tie rods are to be kept tight by means of the turnbuckles, should they become loose. Looseness of the tie rods adversely affects stability of the launchers when fired at maximum traverse.

Section XIX**CONTROL BOX**

49. **GENERAL.** The control box on both launchers is fastened on the rear portion of the tube cluster (figs. 1 and 2). The box on the T66 launcher contains the ten-cap blasting machine, firing handle, firing box, firing cable, telescope mount with elbow telescope, instrument light, cleaning brush and staff, tool kit, and spare parts (fig. 37).

Part Three—Maintenance Instructions

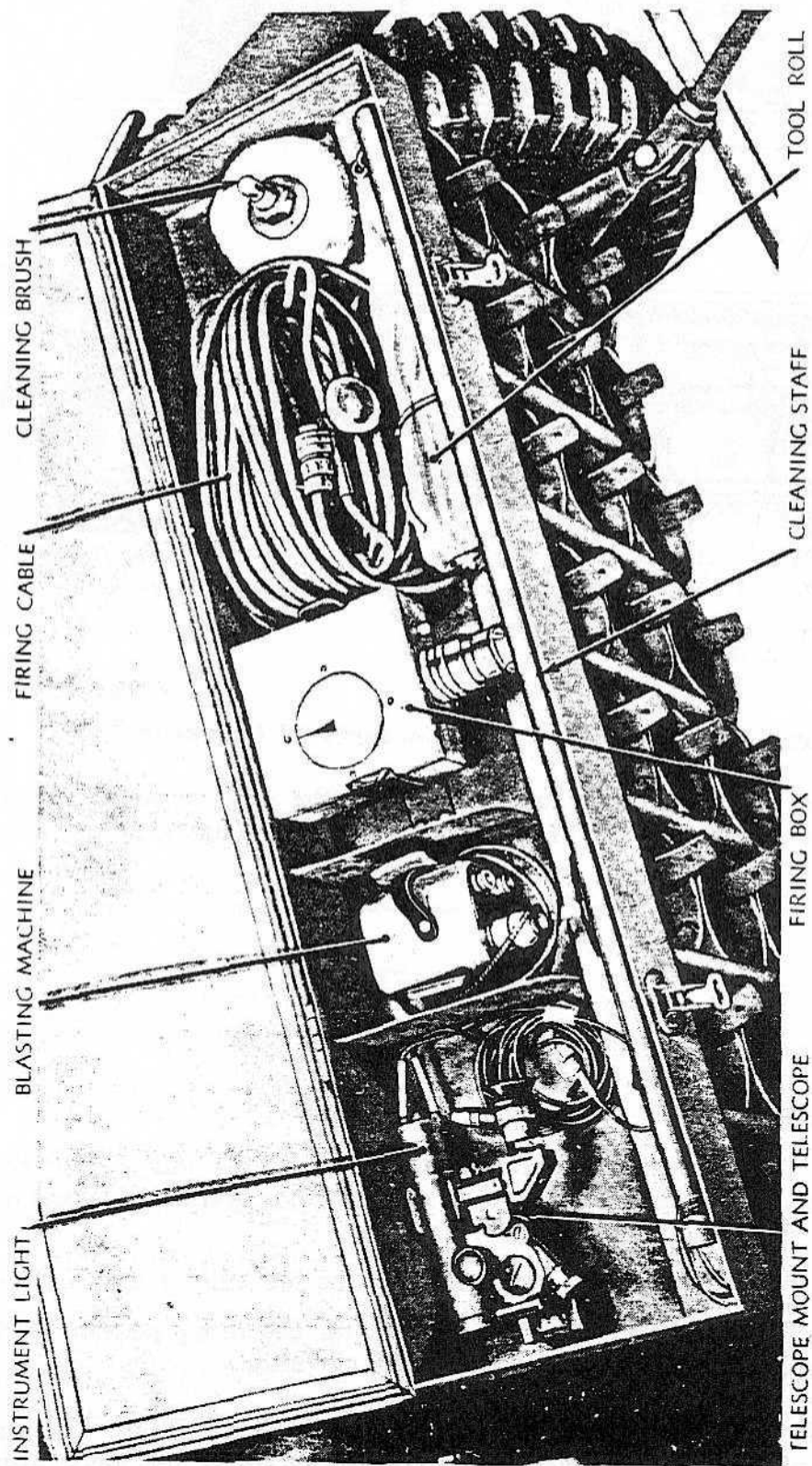

RA PD 104279

Figure 37—Control Box and Contents of Launcher T66

 Part Three—Maintenance Instructions

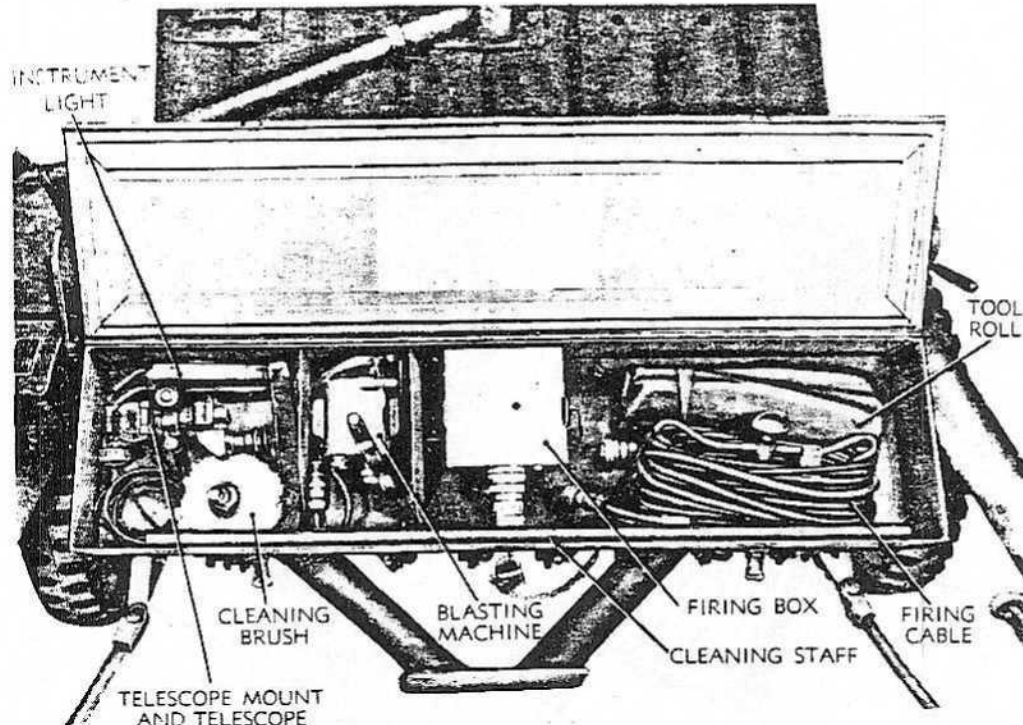

RA PD 104318

Figure 38—Control Box and Contents of Launcher T66E2

The box on the T66E2 launcher contains the same as listed above, with the addition of the blackout lighting system (fig. 38).

 Section XX

ELEVATING MECHANISM

50. GENERAL.

a. The elevating mechanism is located on the left side of the carriage. It is fastened to the tube cluster frame and to a bracket on the carriage side frame (fig. 8).

b. An elevating lock is provided on the left side of the carriage.

c. Two elevation stops are located on the firing pedestal lock to provide a definite stop at maximum elevation.

51. MAINTENANCE OF ELEVATING MECHANISM. Maintenance of the elevating mechanism consists of filling the mechanism with grease (see section XII).

Part Three—Maintenance Instructions

Section XXI**TRAVERSING MECHANISM****52. GENERAL.**

a. The traversing mechanism is located on the left side of the carriage. It is fastened to the tube cluster frame and tube cluster unit (fig. 8).

b. A traversing lock is provided on top of the tube cluster frame.

53. MAINTENANCE OF THE TRAVERSING MECHANISM.

Maintenance of the traversing mechanism consists of filling the mechanism with grease (see section XII).

Section XXII**FIRING PEDESTAL**

54. GENERAL. The firing pedestal is a welded assembly. The pedestal is dropped to the ground for firing position and is locked in place (fig. 5). The pedestal is held in traveling position by locking bars.

Section XXIII**SIGHT BRACKET**

55. GENERAL. The sight bracket is bolted to the front left corner of the tube cluster (fig. 8). A cross-leveling screw is located to the right of the bracket for use in maintaining the telescope mount vertical.

Section XXIV**WHEELS**

56. GENERAL. The wheels are of commercial type and mount a 6.00 x 16 tire. These wheels are directly interchangeable with those used on jeeps.

Part Three—Maintenance Instructions

57. MAINTENANCE OF WHEELS.

a. There is no provision for adjustment of camber, caster, or toe-in on the axle.

b. Pack the wheel bearings with grease, as prescribed on the Lubrication Order (fig. 28).

c. Special attention should be given to keeping the wheel stud nuts tight.

PART FOUR—AUXILIARY EQUIPMENT

Section XXV

GENERAL

58. **SCOPE.** Part Four contains information for the guidance of the personnel responsible for the operation of this equipment. It contains only the information necessary to using personnel to properly identify, connect, and protect such auxiliary equipment while being used or transported with the main equipment. Detailed instructions pertaining to auxiliary equipment are contained in pertinent Technical Manuals.

Section XXVI

AMMUNITION

59. DESCRIPTION.

a. **General.** Rocket ammunition for the multiple launcher T66 and T66E2 is issued in the form of unfuzed complete rounds (fig. 39), except the smoke rocket which is issued fuzed. The rocket is a cylindrical projectile with an ogival nose and square base. It is propelled by reaction to a jet of gas produced within the rocket itself and ejected through a number of nozzles in the base. The nozzles are directed at an angle so as to impart spin as well as thrust, thus furnishing the rocket with a means of stabilization similar to that of an artillery shell.

b. **Types.** Dependent upon the filler, these rockets are classified as high-explosive, smoke, and practice. The high-explosive rocket is loaded with a bursting charge of TNT and is equipped with a point-detonating fuze and booster. The smoke rocket is loaded with phosphorus and equipped with a point-detonating fuze and a burster. The practice rocket is loaded with inert material and equipped with a dummy fuze.

c. **Components.** The complete round (fig. 40) consists of a loaded shell with fuze and booster or burster and a motor containing the propelling charge and an electric igniter. The igniter lead wires pass through one of the nozzles; one is grounded to the rocket body, the other is connected to the contact ring on the closing cup.

Part Four—Auxiliary Equipment



RA PD 10350

Figure 39—HE Rocket M16 and Fuze M81

Part Four—Auxiliary Equipment

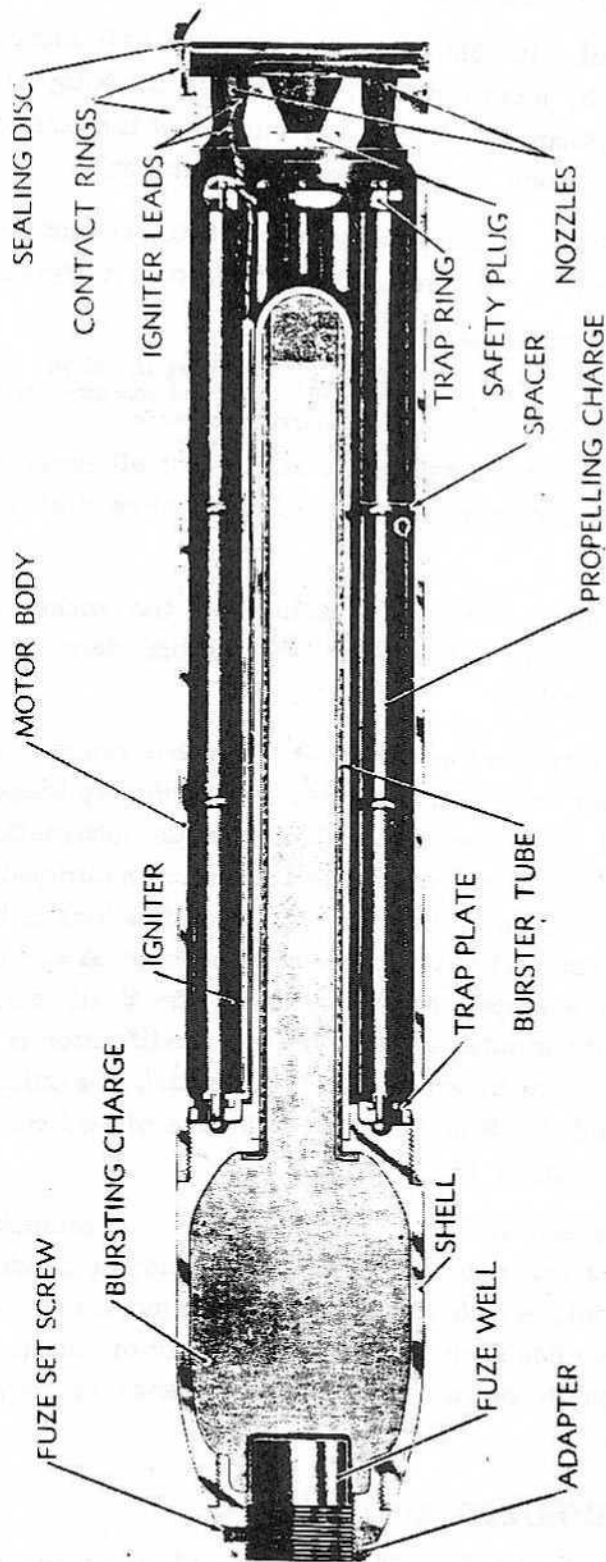

Figure 40—Unfuzed Rocket—Sectional View

*Part Four—Auxiliary Equipment***60. IDENTIFICATION.**

a. **General.** In common with other types of ammunition, rockets are identified by means of the painting and marking on the item and its packings. Positive identification consists of the standard nomenclature of the item and its ammunition lot number.

b. **Painting.** Ammunition is painted to prevent rust and to provide, by the color, a means of identification as to type.

(1) ROCKET SHELL:

High-explosive	Olive drab, marking in yellow
Smoke	Gray, one band and marking all in yellow
Practice	Blue, marking in white

(2) **ROCKET MOTORS.** Since motors for all types of rockets contain full service charge, they are painted olive drab and marked in yellow.

c. **Marking.** Marking stenciled on the rocket includes type, caliber, model, lot number, loaders initials, date loaded, and safe temperature limits.

d. **Standard nomenclature.** Standard nomenclature is established in order that each item may be specifically identified by name. It consists of the name, type, size, and model designation. The model designation is assigned when the item is standardized; it consists of the letter M and an arabic numeral. Modifications of the original design are designated by the addition of the letter A and the appropriate numeral; for example, M6A3 indicates the third modification of an item originally adopted as M6. When a modification is of a temporary nature or does not supersede the basic model, it is indicated by adding a letter: M6A3D. Standard nomenclature of rockets is published in ASF Catalog, ORD 11 SNL S-9.

e. **Ammunition lot number.** A lot of ammunition consists of a number of items, manufactured under uniform conditions from uniform materials, which are expected to function uniformly. The lot number identifies each individual lot of ammunition and is required for all purposes of record making reference to particular items of ammunition.

61. AUTHORIZED ROUNDS.

a. **List of rounds.** The rockets authorized for firing from these launchers and specific data are listed in Table 1.

Part Four—Auxiliary Equipment

TABLE 1

ROCKET	Model	FUZE	Action	LENGTH FUZED (in.)
ROCKET, HE, 4.5", M16	M81 ¹	SQ	0.05-sec delay	31
ROCKET, HE, 4.5", T38E2	T31	VT		31
ROCKET, HE, 4.5", T38E8	M81	} SQ, 0.05-sec delay	} VT	31
	T31 ²			
ROCKET, smoke, WP, 4.5", T84	T36E1	SQ		33
ROCKET, practice, 4.5", M17	T73	Dummy		31

¹Fuze, PD, M81 consists of body of fuze PD M48A2 and booster M24. Fuze, PD, M48A2 with booster M21A1, may be substituted.

²Supplementary charge must be removed from fuze well when this fuze is used.

b. General data. All rockets of this type are designed to be ballistically interchangeable; data common to the type are given in table 2.

TABLE 2

Range maximum	5,200 yd
Dispersion	9 mils
Velocity max.	890 ft per sec
Safe temperature limits	-20° to +130° F
Burning time	0.36 to 0.10 sec
Burn out point	80 ft from launcher
Weight fuze	42.5 lb

c. Differences in models. The various models and modifications differ as follows:

(1) HE ROCKET M16. This is the parent model described above. It is adapted for standard artillery-type fuzes.

(2) HE ROCKET T38E2. This model is similar to the M16 except that it has a deep fuze well for accommodation of special fuzes.

(3) HE ROCKET T38E8. This model is similar to the T38E2 except that the deep fuze well contains a removable supplementary charge. With this charge in place, standard fuzes may be used; by removing the supplementary charge, special fuzes may be used.

(4) SMOKE ROCKET T84. The shell of this model does not have the burster tube extending into the motor, as does the HE shell. Instead, the shell body is slightly longer.

(5) PRACTICE ROCKET M17. This rocket is similar to the HE rocket M16 except that the shell filler is inert.

62. PREPARATION FOR FIRING.

a. In order to prepare the rocket for firing, it is necessary to remove the packing, to fuze the round as described below, and to remove the safety shorting strip and tape from the contact rings. If the rocket is not fired, the safety shorting strip should be replaced, the round defuzed, and all components returned to their original condition and packings.

Part Four—Auxiliary Equipment

b. Fuzing with standard fuzes.

(1) Remove rocket from packings and inspect to see that base sealing disk is in place. If the disk is loose, it may be replaced and the rocket used, provided it can be ascertained that no moisture or other foreign material has entered the motor.

(2) Remove fuze from packings and inspect to insure there is no corrosion and that there are no damaged threads. Set the fuze (fig. 41) for desired action, superquick or delay, by turning the setting sleeve across the axis of the fuze, or delay, or parallel to the fuze axis, for superquick action.

(3) Loosen set screw in adapter and remove shipping plug. Inspect fuze cavity for presence of foreign material and damaged threads. When fuzing T38E8, be sure supplementary charge is present.

(4) Screw fuze into place and tighten with fuze wrench. Tighten set screw in adapter.

c. Fuzing with VT fuzes. Fuzing the T38E2 or T38E8 with special fuzes is essentially the same as the procedure for standard fuzes described above except that the supplementary charge, when present, must be removed. When special action is necessary, directions will be packed with the fuzes.

63. PRECAUTIONS IN HANDLING.

a. Rockets are packed to withstand conditions usually encountered in the field. However, since ammunition is adversely affected by heat, shock, and moisture, due consideration should be given the following:

(1) Packings should not be opened in advance of anticipated needs and items prepared for firing but not used should be restored to their original packings and resealed.

(2) Ammunition should be handled with care at all times. Packings should not be tumbled or dropped. Damaged packings should be repaired or replaced with due care given to transferring all markings.

(3) Rockets and fuzes are particularly sensitive to heat and should be protected against all sources of excessive heat, such as the direct rays of the sun. If it is necessary to store such items in the open, piles should be placed on dunnage and covered with paulins arranged so that air can circulate freely through all parts of the stack.

b. Rockets must not be fired at temperatures outside the safe temperatures marked on the rocket. Firing at temperatures below those specified will result in erratic ranges; firing at temperatures above the safe range will result in dangerous pressures being built up in the rocket motor.

c. Rockets with dented bodies, damaged fuze threads, or missing

Part Four—Auxiliary Equipment

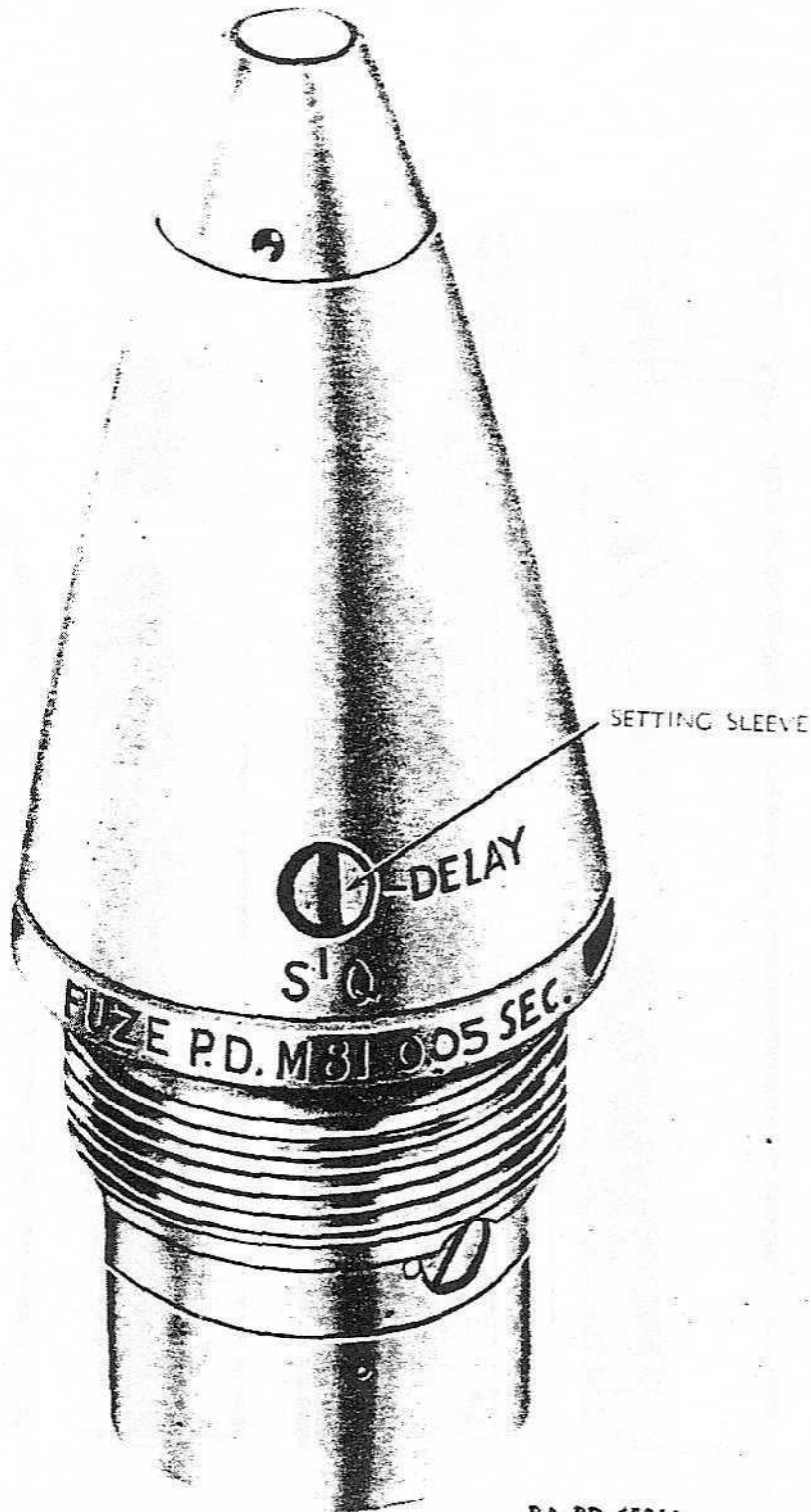

RA PD 65211

RA PD 65211

Figure 41—Fuze M81

Part Four—Auxiliary Equipment

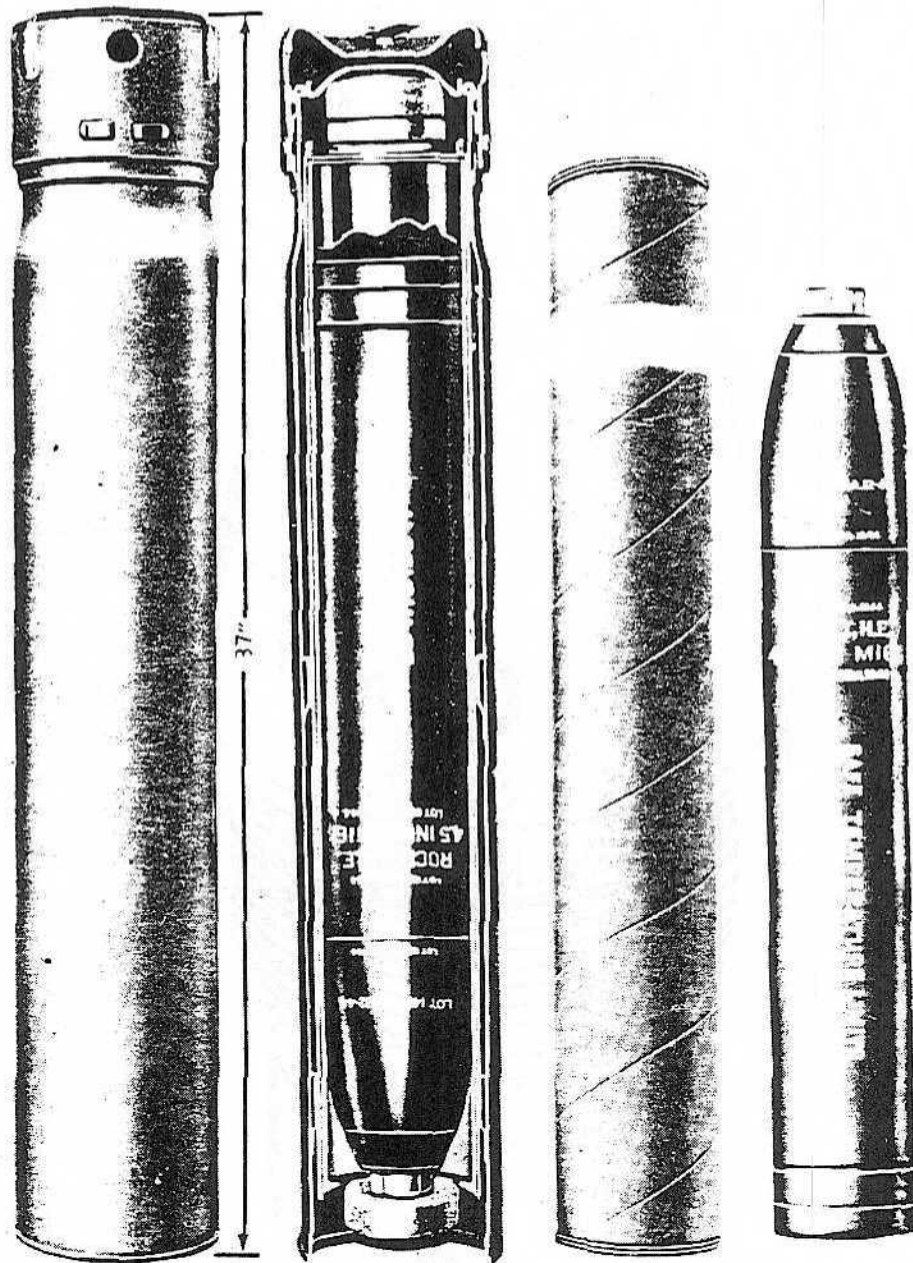

Figure 42—Packings

RA PD 103581

Part Four—Auxiliary Equipment

base closing disks should not be used. If the closing disk is loose, it may be replaced, provided it can be ascertained that no moisture or other foreign material has entered the motor.

d. Fuzes with damaged threads and those showing substantial amounts of corrosion should not be used.

e. When a rocket is fired, the blast of flame extends to the rear approximately 75 feet. Personnel and materiel should be kept clear of this area from the time the launcher is loaded until after the rocket is fired. If practicable, inflammable material such as dry vegetation should be cleared from this area before firing.

f. Care should be exercised to protect the rocket against stray electric currents. If a rocket is accidentally ignited it takes off with full service velocity. The safety shorting strip should be in place across the contact rings at all times except when the rocket is in the launcher.

64. PACKING.

a. Rockets are packed with a shipping plug in place of the fuze in individual fiber containers which, in turn, are packed in metal containers (fig. 42) or wooden boxes. Fuzes are packed in individual sealed containers which are packed in wooden boxes.

b. While dimensions and weights may vary, dependent upon the packing, the following data may be taken as representative for the purpose of making estimates. Complete packing and shipping data are published as soon as available in ORD 11 SNL S-9.

Item	Packed	Dimensions (inches)	Cu Ft	Wt (lb)
ROCKET, HE, 4.5" M16	1/fbr cntr 1/mtl cntr	37 $\frac{1}{8}$ x 6 $\frac{1}{8}$ diam	1.8	
FUZE, PD, M48A2, SQ- .05-sec delay w/ booster M21A1	1/can 15/box	16 $\frac{3}{4}$ x 9 $\frac{3}{4}$ x 9	0.8	50

Section XXVII

SIGHTING AND FIRE CONTROL EQUIPMENT

65. GENERAL. This section contains information on the arrangement of the sighting equipment. It includes instructions for operation and maintenance of each item of on-carriage equipment. Instructions covering off-carriage equipment are not included in this section, but a list of this equipment is contained in paragraph 6. The off-carriage equipment is covered in other Technical Manuals (sec. XXIX).

Part Four—Auxiliary Equipment

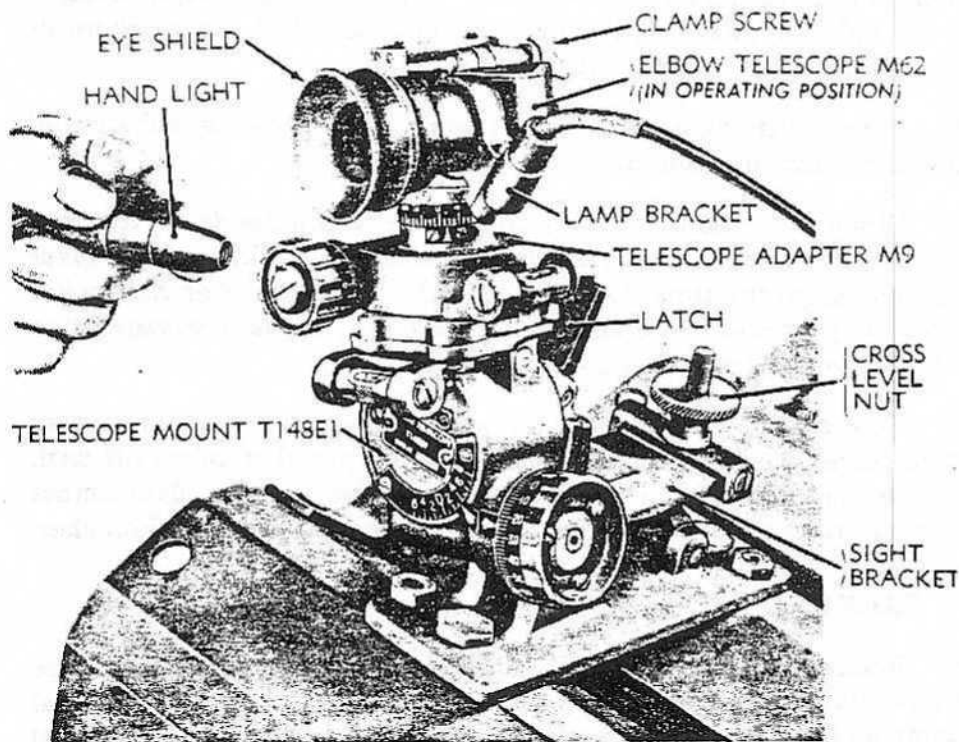

RA PD 102781

Figure 43—Sightunit T128E1—Mounted on 4.5-inch Multiple Rocket Launcher

66. ARRANGEMENT AND USE.

- a. The sighting equipment is designed for direct or indirect fire.
- b. Any one of the following equipment groups may be furnished with the launcher:

(1) **SIGHTUNIT T128E1** (fig. 43). The sightunit includes the telescope mount T148E1 which supports the telescope adapter M9 and elbow telescope M62. The telescope mount is used for setting elevation, the telescope adapter is used for setting azimuth, and the elbow telescope is used for sighting on the target or aiming point. This equipment is secured together as a unit and is not to be separated by the using arm personnel.

(2) **SIGHTUNIT T127E1**. The sightunit T127E1 includes the elevation quadrant T13E5 which supports the telescope adapter M9 and elbow telescope M62. This equipment is identical with sightunit T128E1 except for the elevation quadrant T13E5, which is a light-weight version of the telescope mount T148E1.

(3) **TELESCOPE MOUNT T72E1 WITH ELBOW TELESCOPE M62** (fig. 44). The telescope mount T72E1 supports the elbow telescope M62. The two instruments are not to be separated by the using arm

Part Four—Auxiliary Equipment

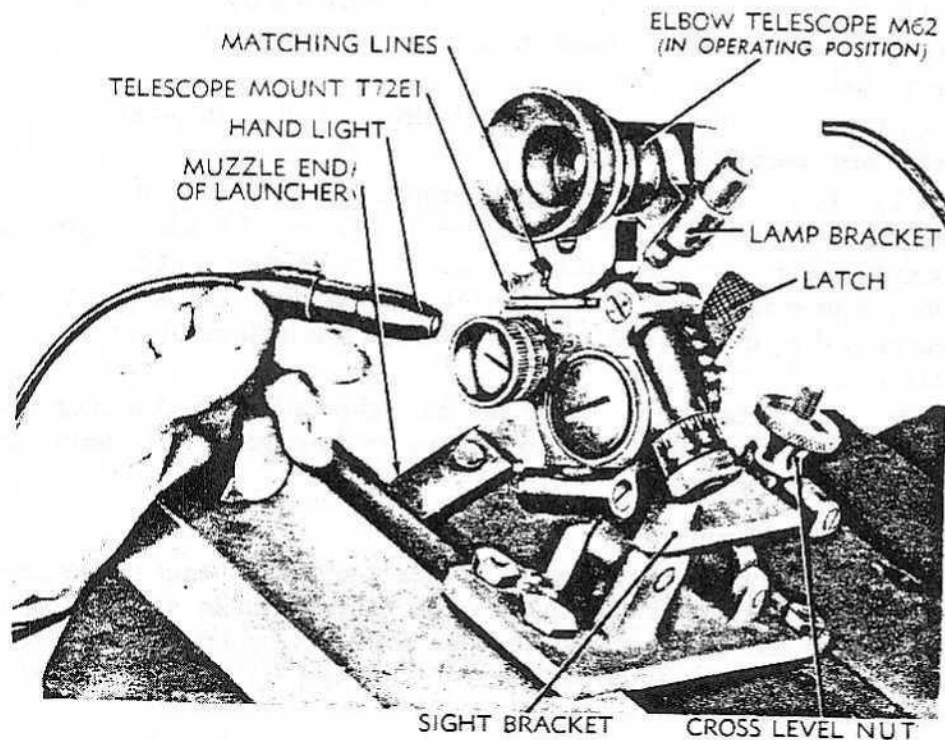

RA PD 102787

**Figure 44—Telescope Mount T72E1 With Elbow Telescope M62
—Mounted on Rocket Launcher**

personnel. The mount includes scales for setting elevation and deflection.

67. MAINTENANCE.

a. Care in handling sighting and fire control instruments.

(1) Sighting and fire control instruments are, in general, rugged and suited for the designed purpose. They will not, however, stand rough handling or abuse. Inaccuracy or malfunctioning will result from mistreatment.

(2) Unnecessary turning of screws, or other parts not incident to the use of the instrument, is forbidden.

(3) Stops are provided on instruments to limit the travel of the moving parts. Do not attempt to force the rotation of any knob beyond the stop limit.

(4) When not in use, keep the instruments in the bracket in the control box of the launcher, or covered and protected from dust and moisture.

(5) Keep the instruments as dry as possible. If an instrument is wet, dry it carefully before placing it in the control box.

Part Four—Auxiliary Equipment

(6) Any instrument which indicates incorrectly or fails to function properly is to be turned in for repair by ordnance maintenance personnel.

(7) No painting of sighting or fire control equipment by the using arm personnel is permitted.

(8) When disengaging the azimuth mechanism of telescope adapter M9 (on sightunit T127E1 and sightunit T128E1), push the azimuth knob outward as far as it will go to be sure that the internal worm and worm gear are completely disengaged. Do not allow the worm to drag over the worm gear teeth as this will result in unnecessary wear of the parts.

(9) Clamping screws must not be tightened beyond a snug contact. Excessive wear of threads and other damage to the instrument are thereby eliminated.

b. Optical parts.

(1) To obtain satisfactory vision, it is necessary that the exposed surfaces of the lenses and other parts be kept clean and dry. Corrosion and etching of the surface of the glass, which interfere with vision, can be prevented or greatly retarded by keeping the glass clean and dry.

(2) Under no circumstances should polishing liquids, pastes, or abrasives be used for polishing lenses and windows.

(3) For wiping optical parts, use only lens tissue paper, specially intended for cleaning optical glass. Use of cleaning cloths in the field is not permitted. To remove dust, brush the glass lightly with a clean artist camel's-hair brush, and rap the brush against a hard body in order to knock out the small particles of dust that cling to the hairs. Repeat this operation until all dust is removed.

(4) Exercise particular care to keep optical parts free from oil and grease. Do not wipe the lenses or windows with the fingers. To remove oil or grease from optical surfaces, apply lens cleaning liquid soap with a tuft of lens tissue paper, and wipe gently with clean lens tissue paper. If this liquid is not available, breathe heavily on the glass (provided the temperature of the surrounding air is above 32°F) and wipe off with clean lens tissue paper. Repeat this operation several times until the lens is clean.

(5) Below freezing temperatures, optics will be cleaned by rubbing gently with dry lens tissue paper. To remove oil film the instrument will be brought into a warm enclosure and allowed to reach room temperature before applying lens cleaning liquid soap.

(6) Moisture may condense on the optical parts of the instrument when the temperature of the parts is lower than the surrounding air. This moisture, if not excessive, can be removed by placing the instrument in a warm place. Heat from strongly concentrated sources should not be applied directly, as it may cause unequal expansion of parts,

Part Four—Auxiliary Equipment

thereby resulting in damage to optical parts and inaccuracies of observation.

c. Batteries.

(1) Batteries used in the instrument light should habitually be removed whenever the lights are not in use. Chemical reaction set up in an exhausted battery will damage the battery tube.

(2) The batteries for the instrument light M42 (T16) are contained in the case of the instrument light. To remove the batteries, unscrew the cap (fig. 47) and slide the two batteries out of the case. When replacing batteries, be sure they go back in the case in the same position as when removed. See that the cap is screwed on tightly to assure contact with the battery terminals.

d. Lubrication. Keep a film of oil on the exposed bearing surfaces of the mounting bracket. Use the lubricating oil for aircraft instruments and machine guns. In areas of high humidity or extreme moisture use preservative lubricating oil (medium) at temperatures above +32°F. Extreme care should be taken not to apply lubricants excessively. Excessive lubrication of certain parts may be as damaging as the absence of any lubricant.

68. SIGHTUNIT T128E1.

a. Installation and removal.

(1) INSTALLATION.

(a) Remove the sightunit from the control box. Insert the dovetailed bracket on the telescope holder in the slot of the sight bracket (fig. 43). When fully inserted, the latch will snap into place, securing the instrument in position. Check to see that the sightunit is firmly seated, latched, and free from motion.

(b) Loosen the winged clamp nut (fig. 43). Rotate the eyepiece of the elbow telescope to the left and in a horizontal position. Tighten the winged clamp nut. This places the instrument in position ready for operation.

(2) REMOVAL.

(a) Press the latch toward the telescope and raise the complete sightunit up and out of the dovetail on the sight bracket. Place the sightunit in position in the control box.

(b) When the sightunit is removed for storage in control box, it will be necessary to loosen the winged clamp nut on the telescope holder and turn the elbow telescope to a vertical position (fig. 45). Tighten clamp nut before placing unit in control box.

b. Telescope mount T128E1 (fig. 43).

(1) The elevation scale is graduated in 100-mil steps between minus 600 and plus 800 mils and numbered every 200 mils. The

Part Four—Auxiliary Equipment

elevation scale is supplemented by the micrometer which is graduated in 1-mil steps from 0 to 100 mils and numbered every 10 mils.

(2) The longitudinal level is equipped with a rotating cover which can be positioned to cover and protect the level vial when not in use.

(3) The required elevation setting is placed in the telescope mount by turning the elevation knob (fig. 45) until the combined reading of the elevation scale and micrometer (registered at the indexes) total the correct amount. The launcher is then layed in elevation by turning the elevation mechanism of the launcher until the longitudinal-level bubble is centered. During this operation the cross-level nut (fig. 43) must be adjusted to hold the cross-level bubble (on the adapter) centered.

(4) The sightunit must be removed from the launcher before firing any rocket.

c. Telescope adapter M9 (fig. 43).

(1) The azimuth mechanism turns the telescope holder (upper section of adapter) in azimuth through the use of the azimuth worm knob (fig. 45).

(2) The azimuth scale is graduated in 100-mil divisions from 0 to 3200 in two consecutive semicircles and is numbered every 400 mils. The micrometer scale (on the azimuth worm knob) is graduated in 1-mil steps from 0 to 100 and numbered every 10 mils.

(3) Large changes in azimuth can be made rapidly by pushing the azimuth worm knob outward to disengage the worm, turning the unit by hand, then reengaging the worm to complete the setting. The setting is then completed by turning the azimuth worm until the combined reading of the azimuth scale and micrometer (registered at the indexes) total the required azimuth setting.

(4) The cross level is equipped with a cover which can be rotated to protect the level vial when the unit is not in use. The movement of the cross level is controlled by turning the cross-level nut on the sight bracket. The sightunit is cross-leveled when the bubble is centered.

d. Elbow telescope M62 (fig. 43).

(1) **DESCRIPTION.** The elbow telescope M62 is a 3-power elbow telescope with a field of view of 12 degrees 12 minutes. The telescope is a fixed focus type, designed for normal eyesight and for ranges ordinarily encountered. The reticle pattern consists of a vertical and horizontal cross line. The cross line is superimposed upon the image when sighting through the telescope. A window below the eyepiece permits illumination of the reticle by an external light source. The telescope is used with the eyepiece extended in a horizontal position (fig. 45).

(2) **ELEVATING MOVEMENT.** The telescope can be moved freely

Part Four—Auxiliary Equipment

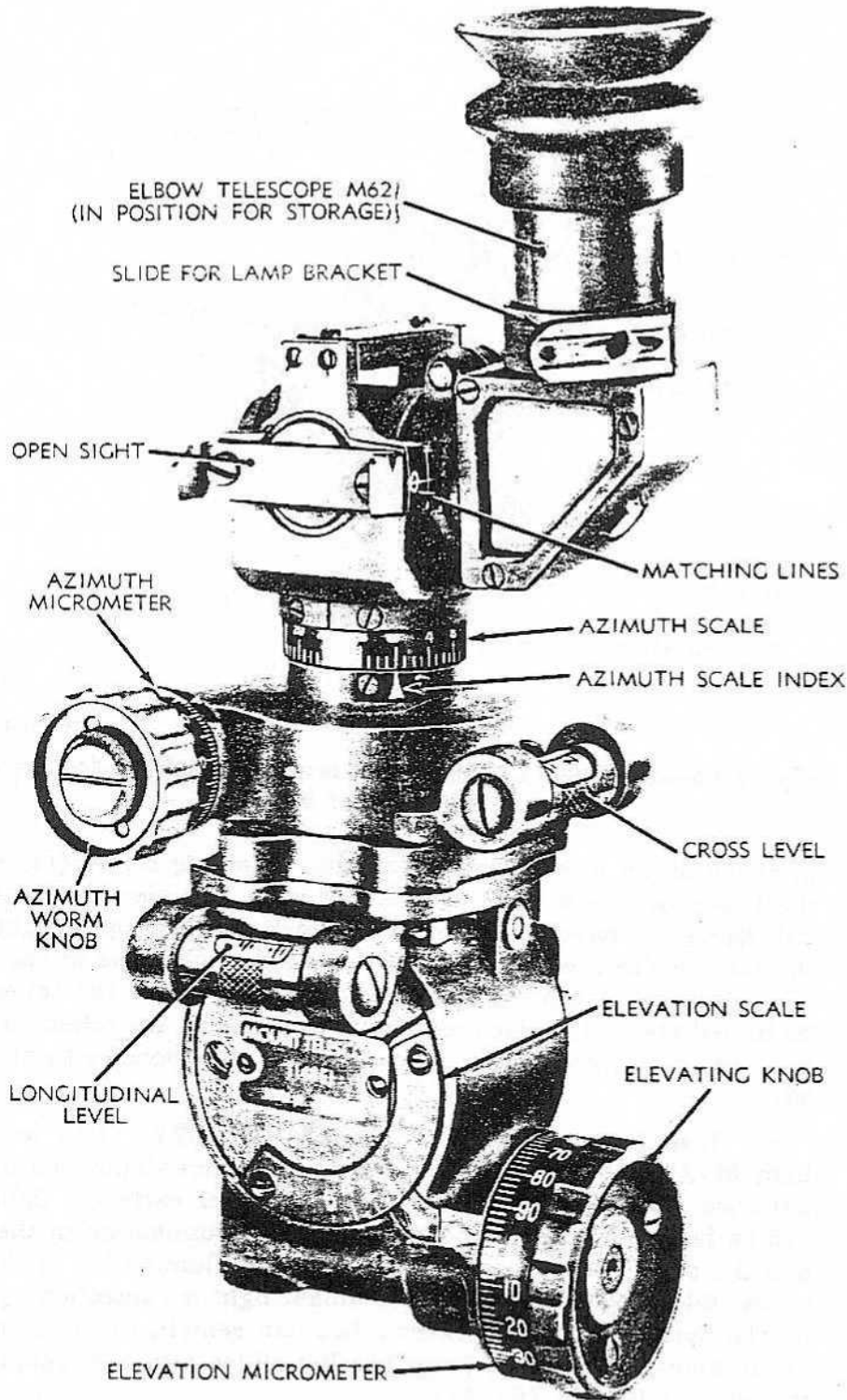

RA PD 102782

Figure 45—Sightunit T128E1—Telescope in Position for Storage—
Left Rear View

Part Four—Auxiliary Equipment

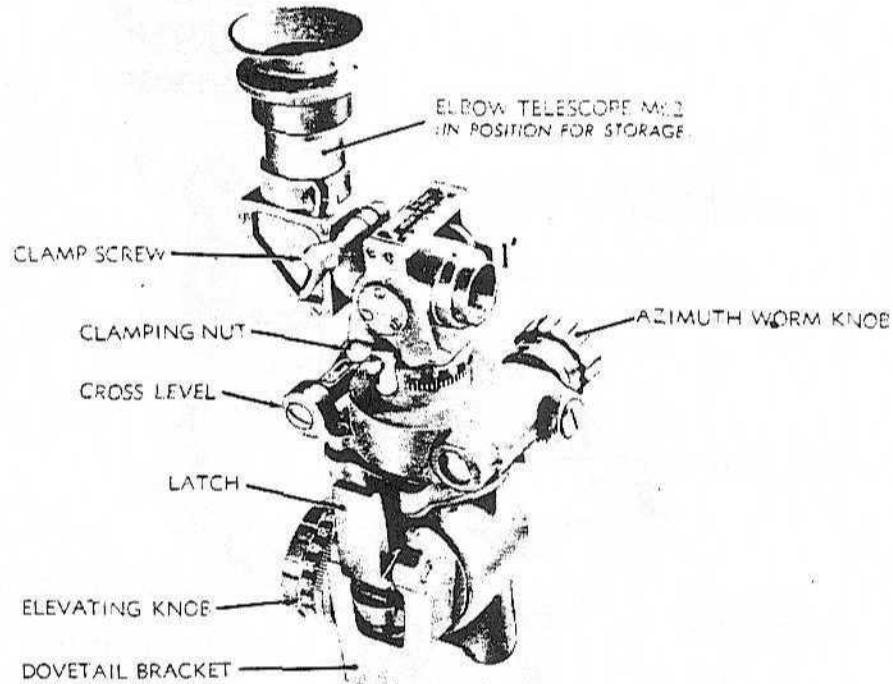

RA PD 102783

Figure 46—Sightunit T128E1—Telescope in Position for Storage—Right Front View

in elevation by loosening the elevation clamping screw (fig. 46), on the telescope holder or it can be locked at any elevation setting by tightening the screw. The matching lines near the open sights show the normal (zero elevation) position of the telescope in the holder. The telescope clamp screw, when loosened, permits the telescope to be turned about its objective axis. For operation, the telescope should be in the horizontal position (fig. 43) with the eyepiece turned to the left.

e. **Instrument light M42 (T16)** (fig. 47). The instrument light M42 (T16) consists of a battery box containing two flashlight batteries and two extension cords. One cord carries a light which can be fastened to the elbow telescope for illumination of the reticle, and the other cord carries a hand light for illumination of the scales on the telescope mount. The instrument light is controlled by a knob on the battery box. The battery box can remain in the control box at all times. The reticle lamp bracket slides into a dovetail slot on the elbow telescope (fig. 43).

f. **Tests and adjustments.**

(1) **GENERAL.** Proper alinement of the levels, pivots, and elbow telescope is accomplished at the factory. No facilities are ordinarily

Part Four—Auxiliary Equipment

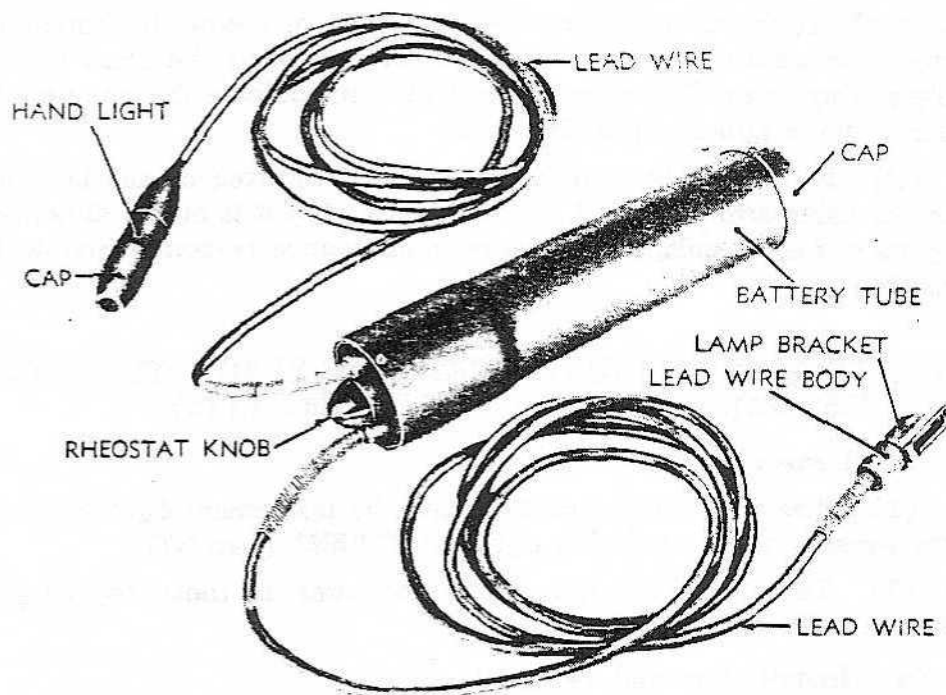

RA PD 102790

Figure 47—Instrument Light M42 (T16)

available for verification of these items in the field and no adjustments by the using arm is permitted.

(2) BORE SIGHTING.

(a) The purpose of bore sighting operation is to test the alignment of the sighting equipment and to provide a basis for adjustment if the sighting equipment is found to be out of alignment.

(b) Facilities required for bore sighting consist of improvised bore sights and a distant aiming point. A cardboard disk with a small hole in the exact center and fitted into one of the launcher tubes will make a good breech sight. The muzzle sight can consist of two strings stretched across the muzzle end of the same tube so that they cross in the exact center of the tube. The aiming point should be a distant object about 1,000 yards away.

(c) *Alignment.* Point the launcher tube with bore sights installed at the distant aiming point. Line up the matching lines on the telescope holder and tighten the clamping screw (fig. 46). Line up the elevation indexes on the telescope mount with the zero on the scale and zero on the elevation micrometer. Line up the azimuth index on the telescope adapter with the zero on the scale and zero on the azimuth micrometer. If the aiming point appears to the right or left of the vertical cross line of the telescope reticle, adjust the azimuth micrometer to bring the cross line on the aiming point. The micrometer will then indicate the amount the unit is out of alignment in

Part Four—Auxiliary Equipment

azimuth. If the aiming point appears above or below the horizontal cross line, adjust the elevation micrometer to bring the cross line on the aiming point. The micrometer will then indicate the amount the unit is out of alinement in elevation.

(d) No bore sighting adjustments are permitted on the launcher by the using arm personnel, but if the adjustment is out of alinement by more than 3 mils, the ordnance maintenance personnel should be notified.

69. TELESCOPE MOUNT T72E1 WITH ELBOW TELESCOPE M62 AND INSTRUMENT LIGHT M42 (T16).

a. General.

(1) The elbow telescope M62 and the instrument light M42 are the same as those used with sightunit T128E1 (par. 68).

(2) Tests and adjustments are the same as those applying to sightunit T128E1 (par. 68).

b. Installation and removal.

(1) INSTALLATION.

(a) Remove the sightunit from the control box. Insert the dovetailed bracket on the telescope holder in the slot of the sight bracket (fig. 44). When fully inserted, the latch will snap into place, securing the instrument in position. Check to see that the sightunit is firmly seated, latched, and free from motion.

(b) Loosen the winged clamp nut (fig. 49). Rotate the eyepiece of the elbow telescope to the left and in a horizontal position. Tighten the winged clamp nut. This places the instrument in position ready for operation.

(2) REMOVAL.

(a) Press the latch toward the telescope and raise the complete sightunit up and out of the dovetail on the sight bracket. Place the sightunit in position in the control box.

(b) When the sightunit is removed for storage in control box, it will be necessary to loosen the winged clamp nut on the telescope holder and turn the elbow telescope to a vertical position (fig. 48). Tighten clamp nut before placing unit in control box.

c. Telescope mount T72E1.

(1) The elevation scale is graduated in 10-degree steps between 0 and 40 degrees and is supplemented by a micrometer graduated in $\frac{1}{4}$ -degree (15-minute) steps.

(2) The longitudinal level is equipped with a rotating cover which can be positioned to cover and protect the level vial when not

Part Four—Auxiliary Equipment

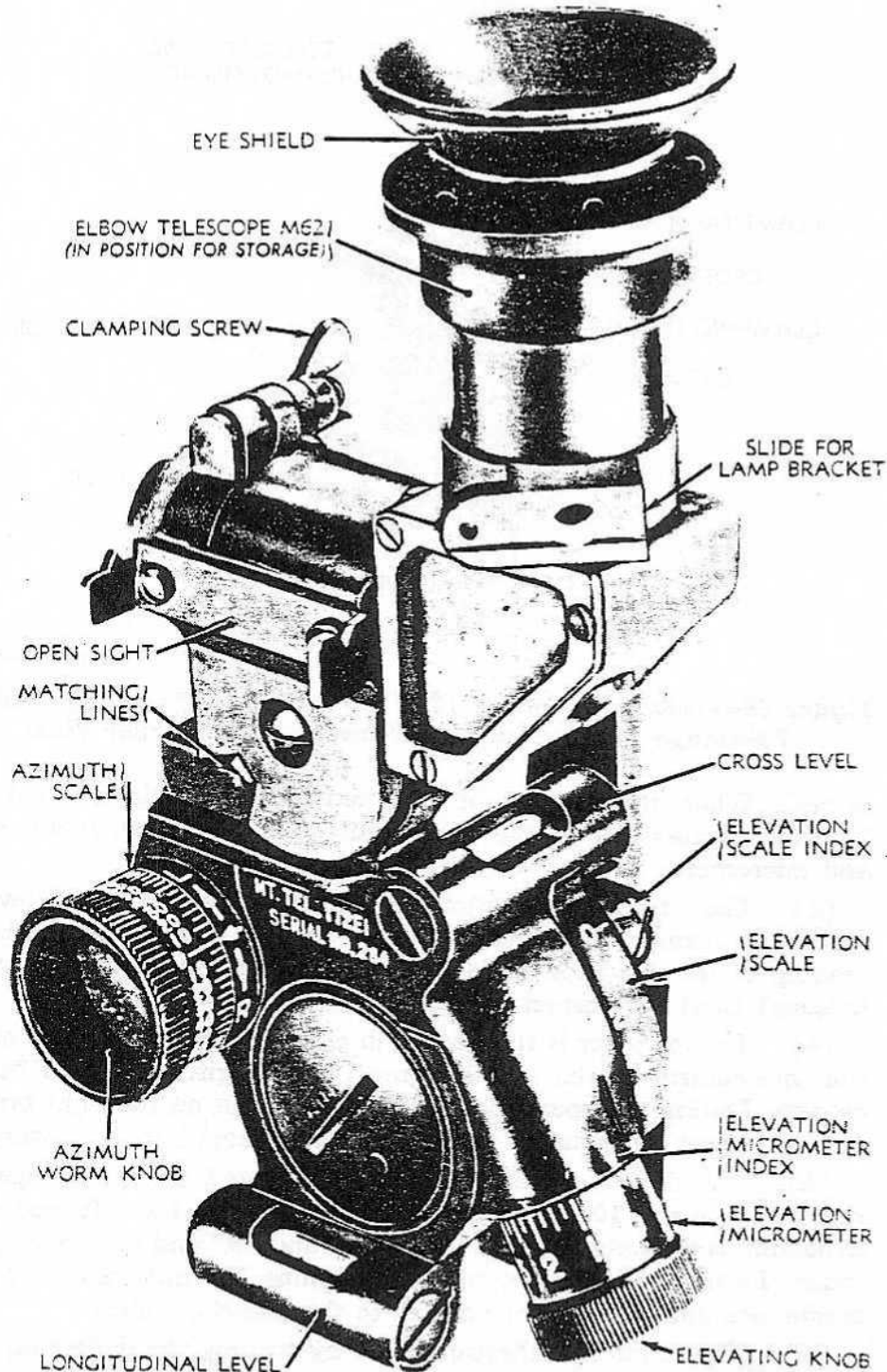
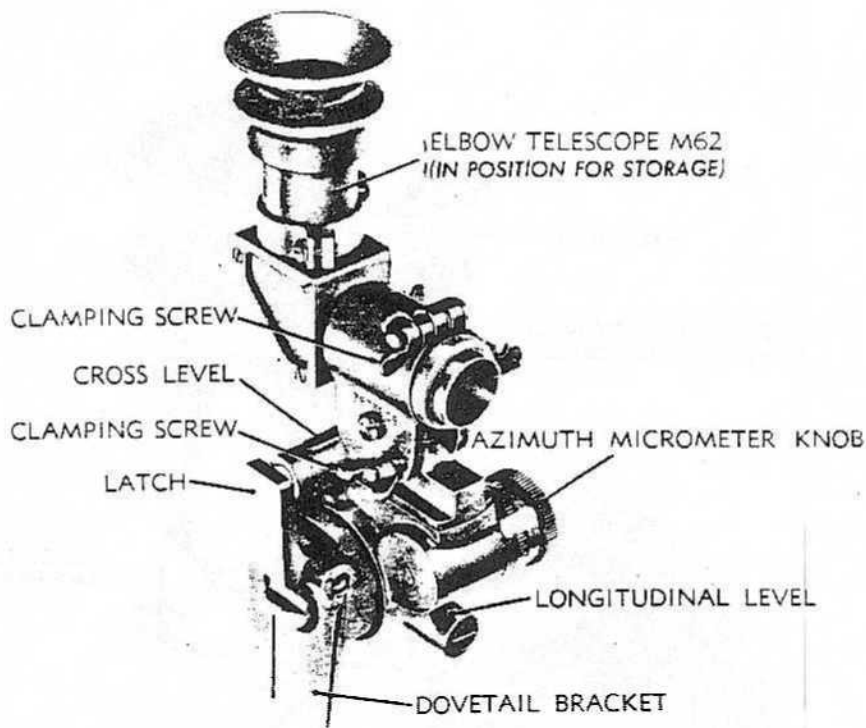

Figure 48—Telescope Mount T72E1 With Elbow Telescope M62—Telescope in Position for Storage—Left Rear View

RA PD 102789

Part Four—Auxiliary Equipment



RA PD 102788

Figure 49—Telescope Mount T72E1 With Elbow Telescope M62—Telescope in Position for Storage—Right Front View

in use. When the level bubble is centered, it indicates that the launcher is elevated to the angle indicated on the elevation scale and micrometer.

(3) The required elevation setting is placed in the telescope mount by turning the elevation knob (fig. 48) until the combined reading of the elevation scale and micrometer (as registered at the indexes) total the correct amount.

(4) The launcher is then layed in elevation by turning the elevation mechanism of the launcher until the longitudinal-level bubble centers. During the operation, the cross-level nut on the sight bracket (fig. 44) must be adjusted to hold the cross-level bubble centered.

(5) The deflection knob scale is graduated in 5-mil steps and numbered every 10 mils. Direction of rotation for left and right deflection is indicated by the letters "L" and "R" and arrows near the index. Deflection is limited to plus or minus 150 mils, and zero indication sets the line of sight parallel to the launcher tubes.

(6) The required deflection is set by turning the deflection knob until the correct amount registers at the index. The traversing hand-wheel of the launcher is then turned until the vertical line of the elbow telescope is laid on the aiming point or aiming post.

APPENDIX

Section XXVIII

SHIPMENT AND STORAGE

70. DOMESTIC SHIPMENT AND LIMITED STORAGE.

a. General.

(1) The 4.5-inch multiple rocket launcher T66 and T66E2 will be shipped and stored in the traveling position.

(2) Preparation for domestic shipment and limited storage will be the same. All precautions must be taken to prevent corrosion of materiel and deterioration of rubber during storage.

(3) Materiel in limited storage is that materiel which is out of service for less than 30 days or materiel that must be ready for operation on call.

b. Materials required. Materials required for preparation for shipment and storage specified throughout this section are listed in section XI, with the exception of items listed below.

COMPOUND, rust preventive, light

COMPOUND, rust preventive, thin film

TAPE, adhesive, non-hygroscopic, O.D.

c. Cleaning.

(1) The launchers will be thoroughly cleaned and made free of all foreign matter with dry-cleaning solvent, soap solution or soda-ash, as follows:

(a) Apply dry-cleaning solvent by scrubbing with a brush or wiping with a clean cloth. Dry all parts thoroughly.

(b) Apply either a warm soda-ash or a soap solution by brushing or scrubbing the surfaces thoroughly until all traces of contamination have been removed. The surfaces will then be rinsed with clean warm water and thoroughly dried. For general cleaning purposes, soda-ash solution consists of $\frac{1}{2}$ pound of soda-ash in 2 gallons of warm water. For cleaning launcher bores, solution will consist of $\frac{1}{2}$ pound of soda-ash in 1 gallon of warm water. Soap solution consists of 1 pound of castile or issue soap in chip form dissolved in 4 gallons of hot water.

(2) Rifle-bore cleaner is used for cleaning launcher bores. It may be used in lieu of dry-cleaning solvent to clean other launcher parts and mechanisms. The cleaner is most efficiently used when undiluted, but when necessary to conserve supply, it may be diluted up to 50 percent with water. (Refer to section XV.) The standard bore brushes and cleaning accessories supplied with materiel are satisfactory for cleaning bores with rifle-bore cleaner. NOTE: *Under no circumstances will a hose, either normal or high pressure, be used in cleaning any sighting equipment or any fire control instruments. Before washing, take off removable sighting equipment from the materiel*

Appendix

to be cleaned. In cases where it is not removable, take care to cover the parts properly.

(3) Avoid contact of bare hands with cleaned surfaces.

d. **Lubrication.** Launchers will be lubricated before rail shipment or storage as prescribed in section XII.

e. **Painting.** All painted metal surfaces that have become pitted or rusted will be cleaned with aluminum oxide abrasive cloth or crocus cloth and repainted where necessary.

f. **Application of preservatives.** Preservatives will be applied immediately after cleaning and drying as a rust stain will form if materiel is handled between operations. Rust-preventive compound (light) used herein must be heated for proper consistency before application. For methods of heating and application of rust-preventive compounds, refer to TM 9-850, dated 24 August 1944.

(1) **LAUNCHER BORES.** Swab each launcher bore thoroughly, using a ramrod and clean cloths soaked in heated rust-preventive compound (light). Repeat operation until all interior surfaces of the bores are thoroughly covered with a protective coating of the preservative.

(2) **EXTERIOR UNPAINTED SURFACES.** Use rust-preventive compound (light) on exterior unpainted operating or machined surfaces from which preservatives will be completely removed before materiel is placed in operation.

g. **Sealing.**

(1) **LAUNCHER TUBES.**

(a) Seal front of launcher tubes by applying one long 6-inch wide strip of nonhygroscopic adhesive tape horizontally across eight tubes, starting left to right.

(b) Overlap this strip with a 4-inch wide strip completely sealing eight tubes horizontally.

(c) Repeat operation for remaining 16 tubes.

(d) Seal vertically by applying 6-inch and 4-inch wide strips across horizontal strips completely covering all 24 tubes.

(e) Spray over tape with rust-preventive compound (thin film).

(f) Repeat operations (steps (a) to (e), above) for sealing rear of launcher tubes.

(2) **CONTROL BOX.** Remove firing handle, firing cable, telescope mount, telescope, etc., and place in control box. Seal all edges of control box with nonhygroscopic adhesive tape.

h. **Covers.** Install covers provided with the materiel and fasten securely.

*Appendix***i. Gun book.**

(1) During transfer or shipment, the gun book must be kept in a waterproof envelope fastened to the cannon with nonhygroscopic adhesive tape.

(2) Under one of the wrappings of tape, one end of a small tab will be inserted, reading "Gun book here."

j. Inspection instructions.

(1) **GENERAL.** A systematic inspection will be made before shipment or storage. All missing or broken parts will be promptly repaired and/or replaced. If repairs cannot be made prior to placing materiel in storage, a tag will be attached to materiel specifying the repairs needed, and a written report of these items will be made to the officer in charge of the materiel.

(2) **LIMITED STORAGE.** A visual inspection will be made weekly during storage to determine general condition. If corrosion is found on any part, remove the rust spots and treat with the prescribed preservative.

k. Removal from storage.

(1) Remove all seals and tape. Remove preservatives, using dry-cleaning solvent. Solutions of soda-ash or soap may be used as a substitute. Dry thoroughly after application of cleaning material and lubricate in accordance with instructions prescribed in section XII.

(2) Repair and/or replace all items tagged in accordance with subparagraph j (1), above.

71. LOADING RULES AND BLOCKING REQUIREMENTS FOR RAIL SHIPMENT.

a. General. Materiel to be loaded and blocked on railroad cars for rail shipment will be prepared in accordance with instructions given in paragraph 71. All loading and blocking instructions as specified herein are minimum. Additional blocking as required may be added at the discretion of the officer in charge.

b. Inspection. Railroad cars must be inspected to see that they are suitable to carry loads safely to destinations. Floors must be sound and all loose nails or other projections, not an integral part of the car, will be removed. Nails, bolts, etc., necessary in car construction when loose, will be made tight rather than removed.

c. Ramps. Permanent ramps will be used for loading materiel, but when such ramps are not available, they may be improvised from rail ties and other available lumber.

d. Handling.

(1) Cars loaded in accordance with specifications given herein must not be handled in hump switching.

Appendix

(2) Cars must not be cut off while in motion, and must be coupled carefully to avoid all unnecessary shocks.

(3) Cars must be placed in yards or on sidings so that they will be subjected to as little handling as possible. Separate track or tracks, when available, must be designated at terminals, classification or receiving yards for such cars, and cars must be coupled at all times during such holding and hand brakes set.

e. **Clearing limits.** The height and width of load must be within the clearance limits of the railroads over which it is to be moved. Army and railroad officials must check all clearances prior to each move.

f. **Maximum load weights.** In determining the maximum weight of load, the following shall govern, except where load weight limit has been reduced by the car owner.

Marked Capacity of Car (lb)	Total Weight of Car and Load (lb)	Load Weights (lb less H. wt. of car)
40,000	66,000	66,000
60,000	103,000	103,000
80,000	136,000	136,000
100,000	169,000	169,000
140,000	210,000	210,000
200,000	251,000	251,000

EXAMPLE

	Lb
Capacity of car.....	100,000
Total weight of car and load.....	169,000
*Light weight of car (to be subtracted).....	37,000
Permissible weight of load.....	132,000

g. **Brake wheel clearance (A, fig. 50).** Load should clear the brake wheel as much as possible, but must not be less than 4 inches below, nor less than 6 inches above, in back and on both sides of the brake wheel. Brake wheel clearance will be increased as much as is consistent with proper location of load.

h. **Distribution of load.** Materiel must be so placed on the car that there will not be more weight on one side of the car than on the other. One truck of the carrying car must not carry more than one-half of the load weight. NOTE: *When loading railroad cars, materiel will be so loaded as to require a minimum number of cars. To accomplish this, various types of materiel may be loaded on the same car provided all have the same destination.*

i. **Tire pressure.** For shipment by rail, the tire pressure will be increased 10 pounds per square inch above normal.

j. **Type of car.** Flat or drop-end gondola cars may be used.

k. **Blocking.** Method of blocking the 4.5-inch multiple rocket launchers T66 and T66E2 will be the same. All blocking pieces will

*This marking is stenciled on each side of car as "LT. WT."

Appendix

be of sound straight-grained wood. (All item reference letters given below refer to the details and locations in figure 50.)

(1) **BLOCKS B, PATTERN 3** (6 in. x 8 in. x 24 in., four required). Locate 45-degree portion of block in front and rear of wheels. Nail heel of block to car floor with three forty-penny cement-coated nails and toenail outside portion to car floor with two forty-penny cement-coated nails before items C are applied.

(2) **CLEATS C, PATTERN 2** (2 in. x 4 in. x 36 in., four required). Locate two cleats against the outside face of wheels. Nail lower cleat to car floor with four thirty-penny cement-coated nails and top cleat to the lower cleat and car floor with four thirty-penny cement-coated nails.

(3) **SUPPORTS D, PATTERN 7** (length to be $\frac{1}{4}$ inch longer than the distance between the axle and car floor to partially relieve weight from the tires, two required). Place support D under the axle near the inside face of each wheel. Nail each support to the car floor with six forty-penny cement-coated nails.

(4) **AXLE STRAPPING E** (two required). Locate two 1-inch No. 14 B. W. gage, hot rolled steel bandings over axle and secure to car floor with anchor plates. Nail anchor plates to car floor with eight twenty-penny cement-coated nails. *NOTE: Four strands, No. 8 gage, black annealed wire or wires of equivalent strength, may be substituted for steel banding. Wires will be secured to car floor by placing a cleat (2 in. x 4 in. x 18 in.) on top of wires and cleat will be nailed to car floor with four thirty-penny cement-coated nails.*

(5) **BLOCKS F** (6 in. x 6 in. x 24 in., four required). Place one block F against the front and rear of each spade. Toenail blocks to car floor with six forty-penny cement-coated nails. Blocks will be cut to fit contour of spades.

(6) **CLEATS H, PATTERN 1** (2 in. x 4 in. x 12 in., two required). Place one cleat H against each side of spade and nail to car floor with three thirty-penny cement-coated nails.

(7) **STAKES J, PATTERN 8** (4 in. x 5 in. x 48 in., two required). Locate in stake pocket of car one-third the distance from the end of trail to the center of the wheels, stake to extend 4 inches below pocket. Drive one forty-penny cement-coated nail into each stake J directly below stake pocket and clinched over outside of pocket.

(8) **TRAIL STRAPPING S**. Secure each trail of the carriage using six strands, two wrappings of No. 8 gage, black annealed wire looped around and over the top of rear end of trail, and secure to stake pockets on both sides of the car. Twist-tie wires with rod or bolt. *NOTE: When a box car or drop-end gondola car is used, apply strapping in a similar fashion, and attach to the floor by use of blocking or anchor plates.*

Appendix

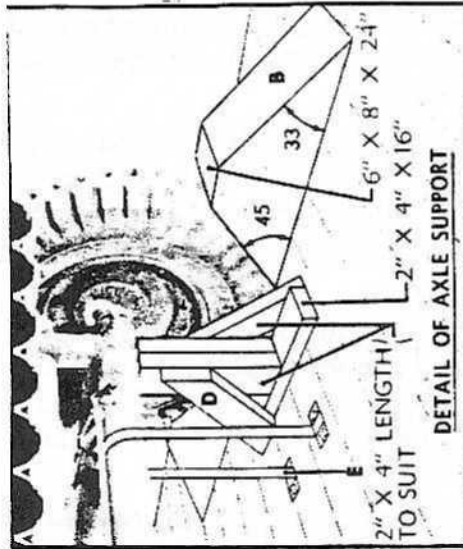

NOTE: METHOD OF BLOCKING THE 4.5-INCH MULTIPLE ROCKET LAUNCHER T66E2 WILL BE THE SAME.

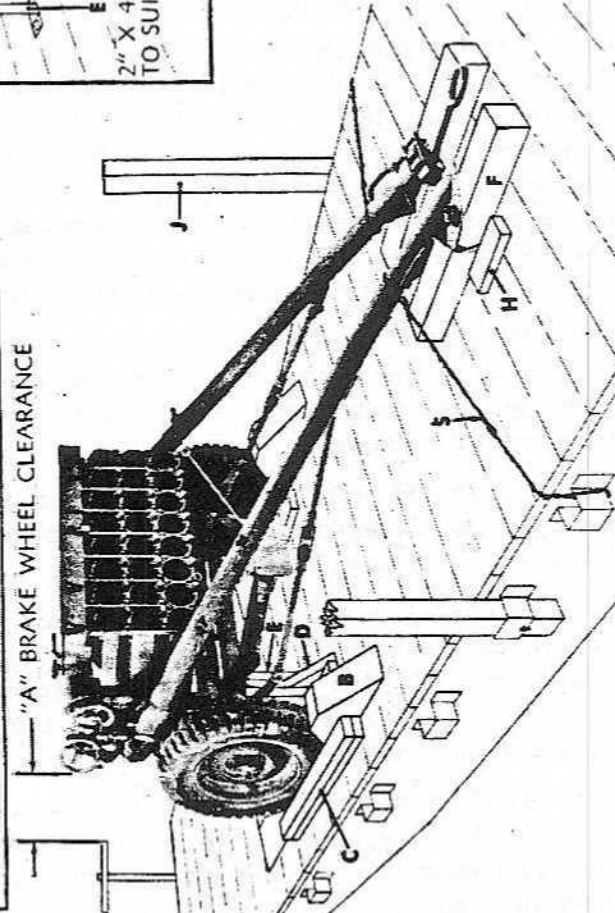
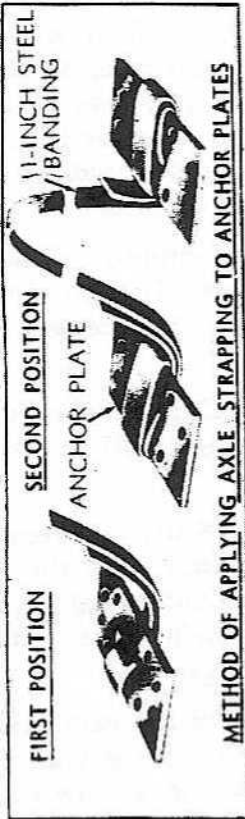

RA PB 102972

Figure 50—Method of Blocking 4.5-inch Multiple Rocket Launcher T66 on Railroad Car

Appendix

72. METHODS OF SLINGING 4.5-INCH MULTIPLE ROCKET LAUNCHERS T66 AND T66E2.**a. General.**

(1) These instructions prescribe procedures, methods, and practices to be followed when the materiel is hoisted, and describe the proper attachment points for slings to permit the materiel to be hoisted in its normal position.

(2) Covers supplied with materiel will be installed and securely fastened.

(3) If operations embrace deep water fording, materiel will be prepared in accordance with TM 9-2853, "Preparation of Ordnance Materiel for Deep Water Fording."

(4) For methods in stevedoring, refer to TM 55-310, "Stevedoring."

b. Sling methods.

NOTE: Due to varying conditions encountered in the field, any of the following procedures may be used, where applicable.

(1) **METHOD I** (fig. 51). Method I employs the following materials:

- (a) Cable slings (heavy enough to support materiel).
- (b) Shackles (placed between lifting cables and slings).
- (c) Lifting cables.
- (d) Lifting hook.
- (e) Cargo runners.

(f) Spreaders (4 in. x 6 in., length as required) are used between cables to obtain a better balance and to provide clearance between slings and materiel to prevent damage when materiel is hoisted. Spreaders consist of two pieces of oak or other hardwood with open ends as shown in figure 51, and are positioned on the cables leading from the lifting hook at a point which will provide clearance between slings and materiel. Slings are placed around materiel at the proper points of balance and attached to the shackles on the lifting cables.

(2) **METHOD II** (fig. 51). Special care must be exercised, when this method is used, to see that proper clearance for fire control brackets, gears, and operating surfaces is maintained when materiel is hoisted clear of ground. Method II employs the following materials:

- (a) Cable slings (heavy enough to support materiel).
- (b) Shackles (placed between lifting cables and slings).
- (c) Lifting cables.
- (d) Lifting hook.
- (e) Cargo runners.

(3) **METHOD III** (fig. 51). Method III employs the following materials:

Appendix

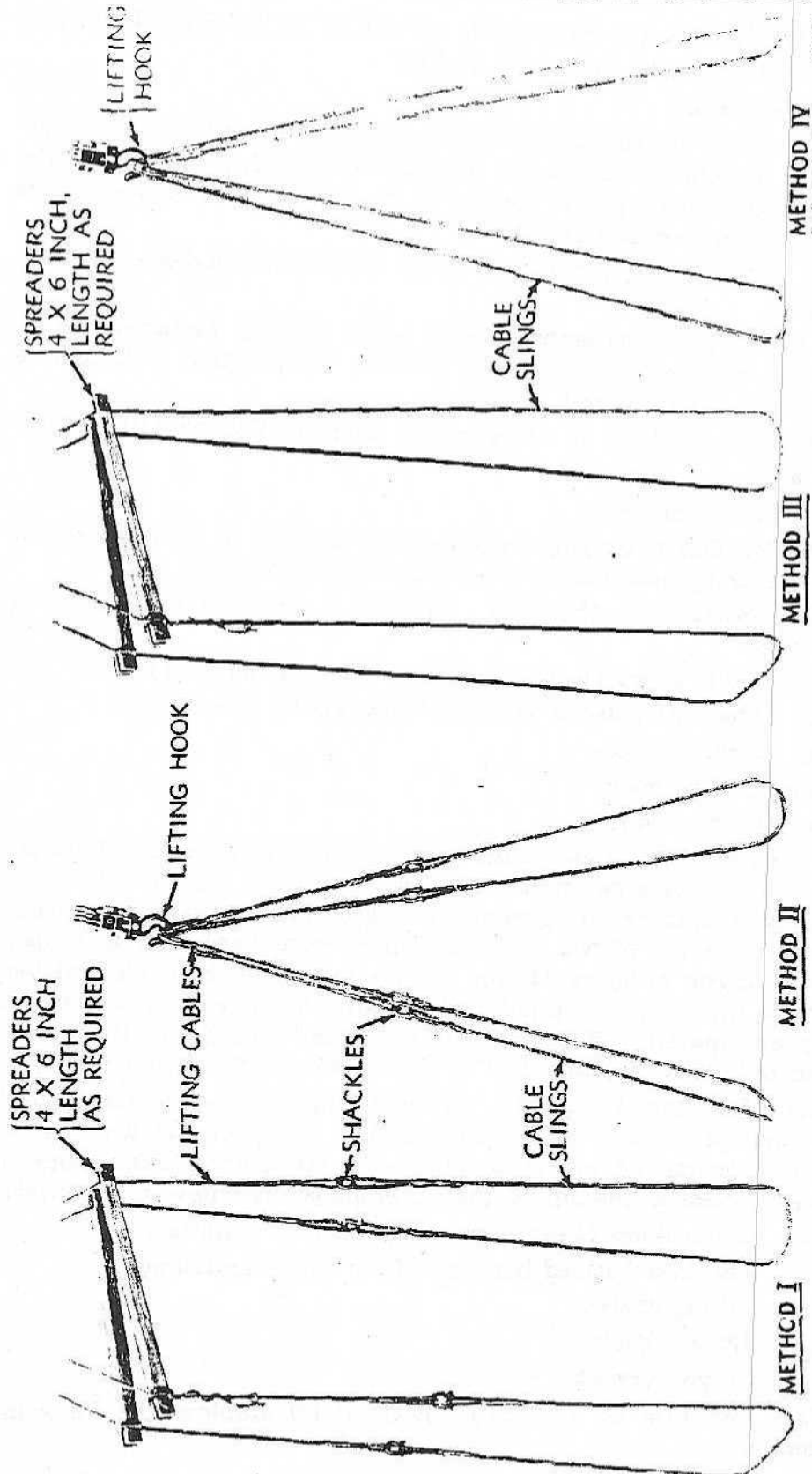

RA 70 96035

Figure 51—Sling Methods Used in Hoisting Artillery Materiel

Appendix

- (a) Cable slings (heavy enough to support materiel).
- (b) Lifting hook.
- (c) Cargo runners.

(d) Spreaders (4 in. x 6 in., length as required) are used between cables to obtain a better balance and to provide clearance between slings and materiel to prevent damage when materiel is hoisted. Spreaders consist of two pieces of oak or other hardwood with open ends as shown in figure 51, and are positioned on the cables leading from the lifting hook at a point which will provide clearance between slings and materiel.

(4) METHOD IV (fig. 51). Special care must be exercised, when this method is used, to see that proper clearance for fire control brackets, gears, and operating surfaces is maintained when materiel is hoisted clear of ground. Method IV employs the following materials:

- (a) Cable slings (heavy enough to support materiel).
- (b) Lifting hook.
- (c) Cargo runners.

c. Cautions during hoisting of materiel.

(1) Before attempting to hoist materiel, an examination of hoisting cables must be made to determine their condition. If strands of cable are broken at any point, a new cable must be substituted. Kinked cables which will not straighten out without damage will not be used.

(2) Under no circumstances must materiel be hoisted when it is found that all weight is balanced on one sling (other sling being loose). Materiel must be lowered to the ground and slings placed in the proper position.

(3) Do not place slings around launcher tubes for hoisting purposes.

(4) All damageable instruments such as fire control equipment, gun sights, etc., must be removed from materiel and securely stowed. *It is imperative that all stowage boxes, tires, or other loose equipment be securely strapped to materiel prior to movement.*

(5) If the under side of materiel has sharp edges at the points where slings are placed, insert dunnage consisting of wood blocks, sacking, clean cloth, or similar material between the slings and materiel in order to prevent cable strands from cutting or slipping.

(6) Attach guy lines to materiel before lifting. Guide materiel during hoisting to prevent damage caused by striking any nearby object or structure.

d. Method of slinging 4.5-inch multiple rocket launchers, T66 and T66E2 (figs. 51 and 52). This type of lift requires the use of two slings and one extra cable.

Appendix

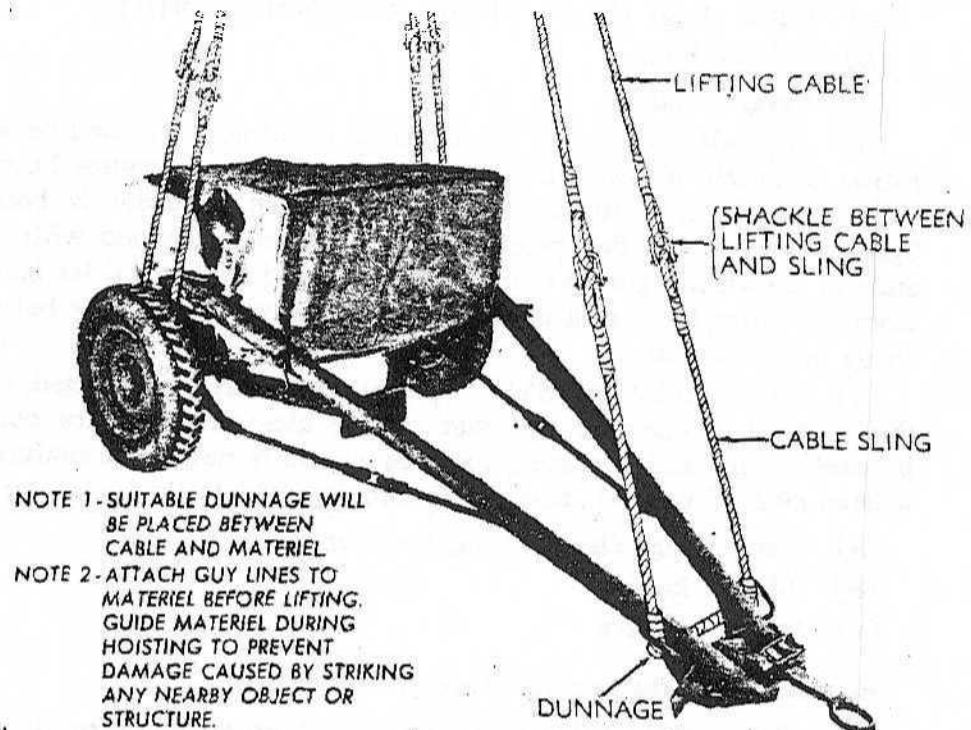

RA PD 102973

Figure 52—Method of Slinging 4.5-inch Multiple Rocket Launcher T66

- (1) Detach one end of both cable slings from the shackles on lifting cables.
- (2) Place the detached end of slings around axle close to wheels and attach to shackles (fig. 52).
- (3) Place the third cable sling around trails, through lifting brackets just ahead of the spades, and attach both ends to shackle on lifting cable.
- (4) Locate dunnage as described in paragraph 72 c (5).
- (5) Attach guy lines (par. 72 c (6)), and hoist materiel slowly, observing proper balance (CAUTION, par. 72 c (2)).

Appendix

Section XXIX

REFERENCES

73. PUBLICATIONS INDEXES. The following publications indexes should be consulted frequently for latest changes or revisions of reference given in this section and for new publications relating to materiel covered in this manual:

- a. Ordnance Supply Catalog Index..... ASF Cat ORD 2
- b. Ordnance Major Items and Combinations,
and Pertinent Publications SB 9-1
- c. List and Index of War Department Publica-
tions (listing new AR's, CCBP's, Cir's,
Forms, FM's, FM's, FT's, GO's, LO's,
MR's, MTP's, MWO's, PCT's, SB's, TB's,
TC's, RR's, TM's, TR's, WDB's, WDP's,
T/O & E's, and similar publications)..... FM 21-6
- d. List of Training Films, Film Strips, and
Film Bulletins FM 21-7
- e. Military Training Aids (listing graphic
training aids, models, devices, and dis-
plays) FM 21-8

74. STANDARD NOMENCLATURE LISTS.

- a. **Cleaning and preserving.**
Cleaning, preserving and lubricating ma-
terials; recoil fluids, special oils, and
miscellaneous related itemsASF Cat. ORD 5 SNL K-1
- b. **Launcher materiel.**
Launcher, rocket, 24-tube, 4.5-in.,
T66ASF Cat. ORD (*) SNL C-67

75. EXPLANATORY PUBLICATIONS.

- a. **Army regulations.**
Qualifications in Arms and Ammunition
Training Allowances AR 775-10
Range Regulations for Firing Ammunition
for Training and Target Practice..... AR 750-10

(*) See ASF Catalog, Ord 2 Index, for published pamphlets of the Ordnance Supply Catalog.

Appendix

- b. **Decontamination.**
 - Decontamination TM 3-220
 - Defense Against Chemical Attack FM 21-40
 - c. **Painting, cleaning, preserving, and lubrication.**
 - Cleaning, Preserving, Lubricating and Related Materials Issued for Ordnance Materiel TM 9-850
 - Maintenance and Care of Hand Tools TM 9-867
 - Maintenance and Care of Pneumatic Tires and Rubber Treads TM 31-200
 - Preparation of Ordnance Materiel for Deep Water Forging TM 9-2853
 - d. **Miscellaneous.**
 - Dictionary of United States Army Terms.... TM 20-205
 - e. **Standard Nomenclature Lists and Technical Manuals covering auxiliary equipment.**
 - Ammunition, General TM 9-1900
 - Auxiliary Fire Control Instruments (Field Glasses, Eyeglasses, Telescopes and Watches) TM 9-575
 - Rockets TM 9-1950
 - Rockets, Ammunition... ASF Cat. ORD 11 SNL S-9
 - f. **Storage and shipment instructions.**
 - Ordnance Packaging and Shipping (Posts, Camps, and Stations)..... TM 9-2854
 - g. **Firing Tables.**
 - RT 4.5 -C -1
 - Graphical firing table T2
- 76. LIST OF FORMS.**
- Form, Government, War Department, Artillery Gun Book..... O.O. No. 5828 (blank)
 - Ordnance Safety Manual..... O.O. Form 7224
 - Unsatisfactory Equipment Report..... W.D. AGO. Form 468

INDEX

A	Page		Page
Accessories	11	Firing controls, operation	13
Ammunition		Firing mechanism	
demolition	31	general discussion	42
descripton	49	maintenance	43
identification and authorized		Firing pedestal	47
rounds	52	Fuzes	54
packing	57		
preparation for firing	53	I	
Ammunition tables	53	Instrument light M42 (T16)	64
Artillery Gun Book	1	Instruments, operation	16
Auxiliary equipment			
general discussion	49	L	
operation	27	Launcher, rocket (See Rocket	
		launchers)	
B		Loading rules	71
Batteries	61	Lubrication, general instructions ...	34
Blocking requirements for rail		Lubrication Order	32
shipment	71		
Bore cleaning	41	M	
		Maintenance	
C		general	32
Carriage		preventive	38
general discussion	43	Malfunctions and corrections	39
maintenance	44	Maximum load weights	72
Cleaning	37		
Control box	44	O	
		Operation under unusual conditions	28
D		Optical parts	60
Demolition to prevent enemy use ..	30		
		P	
E		Pedestal controls, operation	16
Equipment			
operation (auxiliary)	27	R	
service upon receipt		Rifle bore cleaner	41
new	12	Rocket launchers	
used	13	demolition	31
(See also Sighting equipment and		description	2
Fire control equipment)		firing	26
Elevating controls	13	identification, data, and differ-	
Elevating mechanism	46	ences in models	9
		loading	25
F		placing in:	
Field report of accidents	2	firing position	16
Fire control equipment		traveling position	27
arrangement and use	58	shipment and storage	
general discussion	57	cautions during hoisting	77
lubrication	61	methods of slinging	75, 77
		traversing and elevating	22

Index

R—Contd.	Page	T	Page
Rockets		Telescope, elbow, M62	62
differences in models and preparation for firing	53	Telescope adapter M9	62
packing	57	Telescope mount T128E1	61
precautions in handling	54	Telescope mount T72E1 W/telescope M62 and instrument light M42 (T16)	66
S			
Service upon receipt of equipment	12	Tie rods	44
Shipment and storage	69	Tools	10
Sight bracket	47	Trails	44
Sighting equipment		Traversing controls	13
arrangement and use	58	Traversing mechanism	47
data	10	Tube, cleaning	29
general discussion	57	Tube cluster, maintenance	40
lubrication	61	Tube cluster traveling lock	13
maintenance	59	U	
Sight unit		Unsatisfactory equipment record ..	2
installation and removal	61	W	
tests and adjustments	64	Wheels	
Spare parts, organizational	10	general discussion	47
		maintenance	48